

 UPPAbaby[®]
KNOX[®]



ENGLISH

Product Information	2	Multi Directional Tether Use and Storage	31
Registration	2	Recline Adjustment	34
Certification	2	Rear-Facing Installation	36
Lifetime Warranty	3	Rear-Facing Setup	38
Warnings + General Safety Information	4	Vehicle Seat Recline	40
Vehicle Compatibility	10	Lap/Shoulder Belt Use	42
Lower Anchors and Tethers for Children (LATCH)	13	Lap Belt Only Use	44
Overview of Vehicle Seat Belt Systems	14	LATCH Setup	46
Child Usage Requirements	16	LATCH Use	48
Features Overview	18	Rear-Facing Tether Use	50
Harness Usage	22	Aircraft Use	52
Active Support Headrest Adjustment	24	Safety Check	53
Fit Inlay	25	Forward-Facing Installation	54
Cup Holder Usage	26	Forward-Facing Setup	56
Rear-Facing and Forward-Facing Belt Tensioning Plates	27	Lap/Shoulder Belt Use	58
LATCH Setup	28	Lap Belt Only Use	60
LATCH Use and Storage	30	LATCH Setup	62

Read all instructions before use of this Child Restraint. Keep these instructions for future reference.

LATCH Use	64
Forward-Facing Tether Use	66
Aircraft Use	68
Safety Check	69
Securing the Child	70
Fabric Care	72
Removing Seat Pad	72
Removing Headrest Fabric	74
Removing Seat Fabric	76
Installing Seat Fabric	78
Installing Headrest Fabric	80
Installing Seat Pad	82
Cleaning and Maintenance	84
Warranty	85

PRODUCT INFORMATION

REGISTRATION

Model Number: _____

Manufactured Date: _____

Expiration Date: _____



PLEASE TAKE A MOMENT TO FILL OUT THE ABOVE INFORMATION which can be found on the bottom of your KNOX Child Restraint. Thank you for selecting the KNOX Child Restraint from UPPAbaby.

Please register your Child Restraint by filling out and sending the postage-paid registration card that came with your Child Restraint or register online at: uppababy.com/registration/carseat.

Child Restraints can be recalled for a variety of safety reasons. **You MUST register this restraint to be reached in a recall.**

For recall information, call the U.S. Government's Vehicle Safety Hotline at 1-888-327-4236 (TTY: 1-800-424-9153), or go online to nhtsa.gov.

CERTIFICATION



This Child Restraint system conforms to all applicable Federal Motor Vehicle Safety Standards (FMVSS).



This Child Restraint is certified for aircraft use. UPPAbaby and the Federal Aviation Administration (FAA) strongly urge you to secure your child in a Child Restraint system (CRS) or device for the duration of your flight.

WELCOME TO THE FAMILY

We are with you for the long haul. Register your car seat within three months to claim your

Limited Lifetime Warranty.*

Thank you for being part of the UPPAbaby family.



*Lifetime warranty applies to UPPAbaby car seats and the original owner, within the lifetime of the product. To receive your Limited Lifetime Warranty, you MUST register within three months of purchase and provide a valid purchase receipt from an authorized UPPAbaby retailer. The "lifetime" of the product is defined as the period of use by the registrant for use with his/her children up to 10 years from date of manufacture. For complete UPPAbaby Warranty refer to page 85.

For replacement parts, service or additional questions, please contact our Customer Experience Team:
uppababy.com/support | email: support@uppababy.com | 844-823-3132

WARNINGS + GENERAL SAFETY INFORMATION

WARNING

DEATH OR SERIOUS INJURY CAN OCCUR

According to accident statistics, children are safer when properly restrained in the rear seating positions than in the front seating positions. Never leave Child Restraint unsecured in your vehicle even when it is unoccupied. In a crash, it could become a projectile and injure other vehicle occupants.



NEVER place this Child Restraint on a front seat with an airbag. **DEATH OR SERIOUS INJURY** can occur. An airbag can strike a rear-facing infant restraint with enough force to crack the shell and seriously injure or kill an infant. The back seat is the safest place for children 12 and under. Refer to the vehicle owner's instruction book before installing this Child Restraint in a seating position with side airbags.

WARNINGS + GENERAL SAFETY INFORMATION

Snugly adjust the belts provided with this Child Restraint around your child. A snug strap should not allow any slack. It lies in a relatively straight line without sagging. It does not press on the child's flesh or push the child's body into an unnatural position.

WARNING

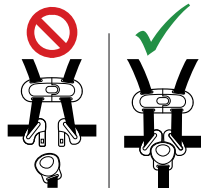

Children have **STRANGL**ED in loose or partially buckled harness straps. Fully restrain the child in the seat at all times. **DO NOT** put a child in the seat outside of the vehicle.

WARNINGS + GENERAL SAFETY INFORMATION

SAFETY WARNINGS

Failure to follow these instructions could result in serious injury to your child or other vehicle occupants.

- **NEVER** leave child unattended.
- **ALWAYS** keep child properly harnessed when child is in Child Restraint.
- **NEVER** leave child in Child Restraint when straps are loose or undone.
- **DO NOT** use seat if damaged or broken, expired (over 10 years from date of manufacture), missing instructions, missing parts, or if the straps are cut, frayed, or damaged in any way.
- **DO NOT** use this Child Restraint system if it has been in a vehicle accident.
- **DO NOT** use clothing or blankets that interfere with fastening or tightening the harness **INSTEAD** place a blanket over the child after being properly secured in the harness.

WARNINGS + GENERAL SAFETY INFORMATION

- **DO NOT** use this Child Restraint system if the top of the child's head is less than 1" from the top of the headrest when in its highest position.
- **DO NOT** use this Child Restraint system in a vehicle seating position where it cannot be tightly secured.
- **DO NOT** install in rear-facing or side-facing vehicle seats.
- **DO NOT** modify this restraint except as instructed in this instruction book. Minor modifications can change the way a Child Restraint performs in a crash.
- **DO NOT** leave loose objects, e.g. cups, toys, bags, umbrellas, etc., in the vehicle because they can become deadly projectiles in a crash.
- **DO NOT** take child out of the Child Restraint while the vehicle is moving.
- **DO NOT** allow children to play with this Child Restraint. It is not a toy.
- **DO NOT** remove or cover up any of the warning or product labels on this Child Restraint. All labels include information required by law.

WARNINGS + GENERAL SAFETY INFORMATION

- **DO NOT** use any accessories, pads, or products supplied by other manufacturers with this Child Restraint, unless approved and tested by UPPAbaby. Items not tested with this restraint could injure your child.
- **DO NOT** lubricate buckles and fasteners.
- **DO NOT** use a Child Restraint with damaged or missing parts.
- **ALWAYS** check all surfaces of restraint before securing your child. In warm weather, Child Restraints can become very hot. Park in the shade or where sun does not directly hit the Child Restraint. Cover the Child Restraint with a sheet or blanket when not in use.
- **ALWAYS** properly store lower anchor connectors when not in use.

WARNINGS + GENERAL SAFETY INFORMATION

- Check the vehicle owner's manual for more information about airbag/Child Restraint use.
- For vehicles without a back seat, refer to your vehicle owner's manual.
- Check the vehicle belt before each use. Use only if the belt is tightened properly and securely.
- Placing your child in a hot Child Restraint may result in burns.
- Read all instructions for additional warnings.

VEHICLE COMPATIBILITY

PLEASE READ THE FOLLOWING INFORMATION BEFORE INSTALLING THIS CHILD RESTRAINT!



⚠ WARNING:
**DEATH OR SERIOUS
INJURY CAN OCCUR
NEVER** install this Child

Restraint rear-facing in a vehicle seating position with a frontal air bag unless it is turned off. If your vehicle is equipped with front passenger side air bags, check your vehicle owner's manual for Child Restraint installation instructions.

IMPORTANT: According to accident statistics, children are safer when properly restrained in the rear seating positions than the front seating positions. Child Restraint systems should be secured to the vehicle, even when not occupied, since in a crash an unsecured child restraint system may injure other occupants.

VEHICLE COMPATIBILITY

The safest seating position is one that works best for your specific car seat, family and vehicle where you are able to achieve the tightest install every time. Before installing this Child Restraint you **MUST** determine the method of installation and the best vehicle seating position for that method. This Child Restraint can be installed either using the **Vehicle Seat Belt** or **LATCH**. When determining the best method of installation, it is critical that you refer to your vehicle owner's manual.

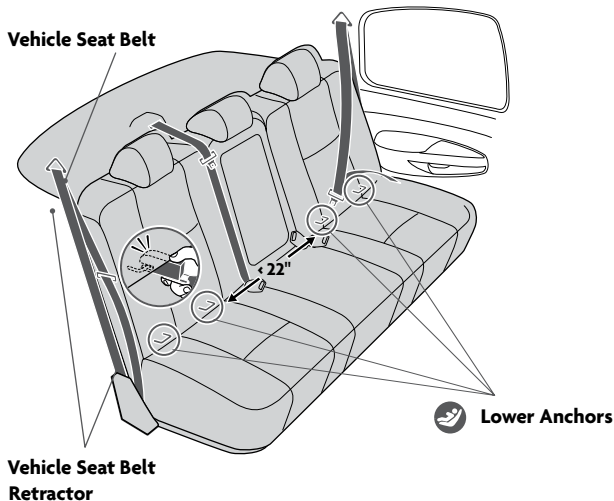

VEHICLE COMPATIBILITY

This Child Restraint can only be installed on vehicle seats that face forward. **DO NOT** install in seats that face to the sides or rear of the vehicle.

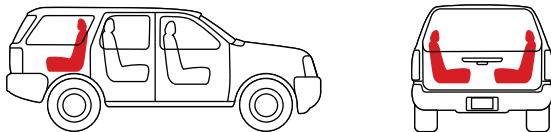

ALWAYS park on a level surface when installing a Child Restraint.

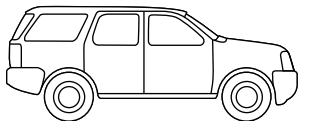

Center seat installation of the KNOX is not compatible in vehicles with the following rear vehicle seat configurations:

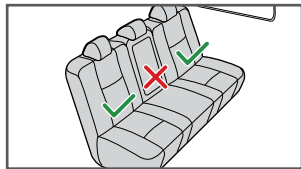

60/40 Split Rear Seat

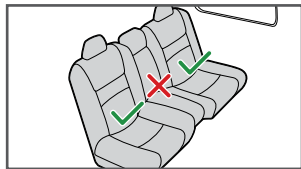

Convex (hump) Center Seat

In vehicles with these seat constructions we recommend an outboard installation.

VEHICLE COMPATIBILITY – LATCH (Lower Anchors and Tethers for Children)

LATCH (Lower Anchors and Tethers for Children)

is a system that provides an alternative installation method to vehicle seat belts.

ALWAYS refer to your vehicle owner's manual to determine if your vehicle is equipped with LATCH and in what seating positions.

NOTE: Use of lower anchors in the rear center seating position must be approved by the vehicle manufacturer and may be up to 22". If spacing is greater than 22" or if the seating position is not approved by the vehicle manufacturer, then use the vehicle seat belt for installation.

⚠ WARNING: DO NOT use the Lower Anchorage System (LATCH) to attach this Child Restraint when restraining a child weighing more than **30 lbs (13.6 kg)** for Rear-Facing installation and **35 lbs (15.9 kg)** for Forward-Facing installation.

Vehicle Top Tether Anchor Points

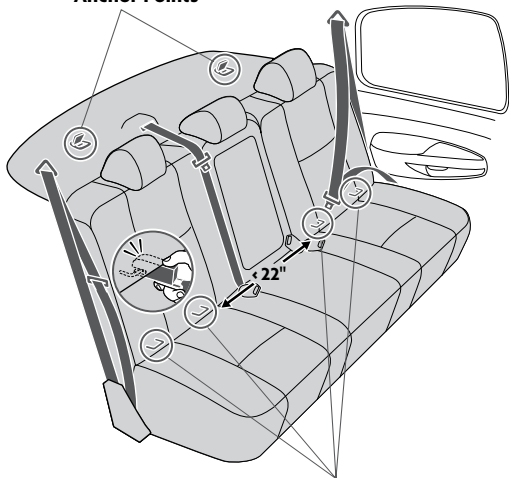

Vehicle Lower Anchor Points

VEHICLE COMPATIBILITY – Overview of Vehicle Seat Belt Systems

DO NOT use this Child Restraint with the following seat belt systems:

⚠ WARNING: DEATH OR SERIOUS INJURY CAN OCCUR. CHECK YOUR Vehicle instruction book for information regarding your vehicle seat belt system(s). Not all vehicle seat belts work with this Child Restraint.

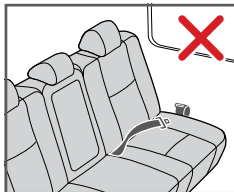

Lap belts with emergency locking retractor

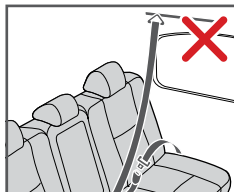

Motorized (automatic)

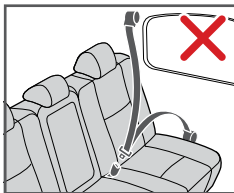

Lap/Shoulder with two retractors

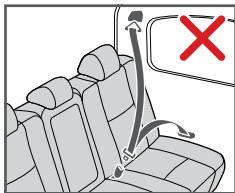

Door mounted

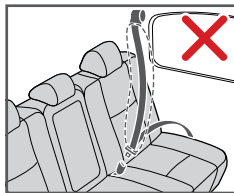

Inflatable

VEHICLE COMPATIBILITY— Overview of Vehicle Seat Belt Systems

Check your vehicle owner's manual

Vehicle seat belts differ from vehicle to vehicle. This Child Restraint is compatible with most vehicle seat belt systems as shown here.

Belts MUST be able to lock

Refer to vehicle owner's manual to determine if the belts in your vehicle lock by switching the seat belt's retractor or they have a locking latch plate that locks the vehicle's seat belts so they will not move freely.

If the belt cannot be locked using one of these methods, contact UPPAbaby Customer Experience Team for a locking clip.

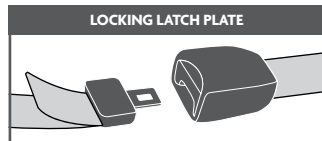
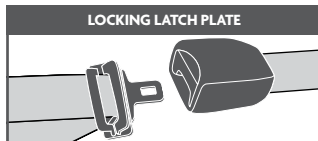
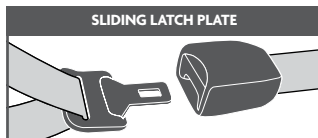
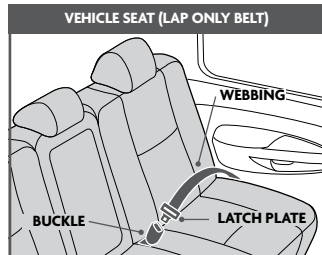
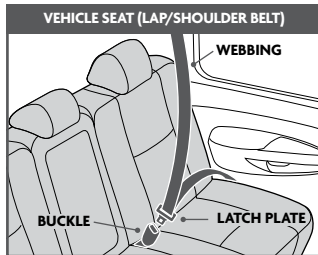

CHILD USAGE REQUIREMENTS

To use this Child Restraint, your child **MUST** meet **ALL** of the following weight and height requirements:

WEIGHT REQUIREMENTS:

14–65 lbs (6.4–29.5 kg)

HEIGHT REQUIREMENTS:

49 in (123 cm) or less

The Fit Inlay
is designed for children who weigh
14–25 lbs (6.4–11.3 kg)

UPPAbaby recommends that children ride rear-facing in the KNOX as long as possible, until they reach the maximum weight (45 lbs (20.4 kg)) or height allowed in this mode.

CHILD USAGE REQUIREMENTS

REAR-FACING INSTALLATION

14–45 lbs (6.4–20.4 kg)

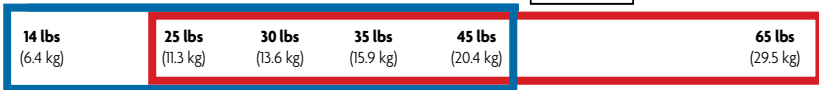
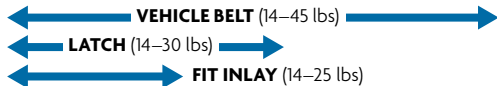

FORWARD-FACING INSTALLATION

25–65 lbs (11.3–29.5 kg)

⚠ WARNING: DO NOT use the Lower Anchorage System (LATCH) to attach this Child Restraint when restraining a child weighing more than **30 lbs (13.6 kg)** for Rear-Facing installation and **35 lbs (15.9 kg)** for Forward-Facing installation.

FEATURES OVERVIEW

- 1 Shoulder Harness Pads
- 2 Harness Buckle
- 3 Crotch Pad
- 4 Harness Release Button
- 5 Harness Adjuster Strap
- 6 Lower Anchor Connector LATCH Storage
- 7 Fit Inlay
- 8 Cup Holder
- 9 Retainer Clip (Chest Clip)

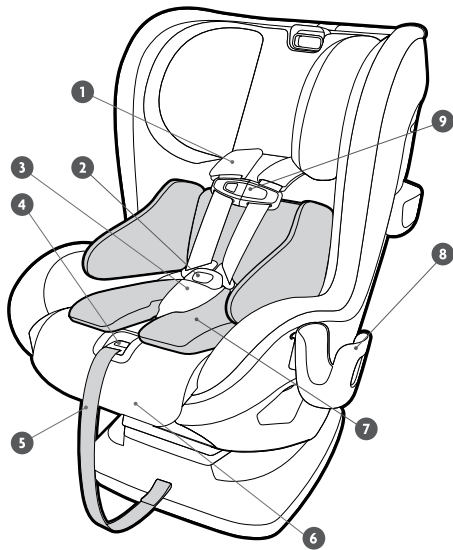

FEATURES OVERVIEW

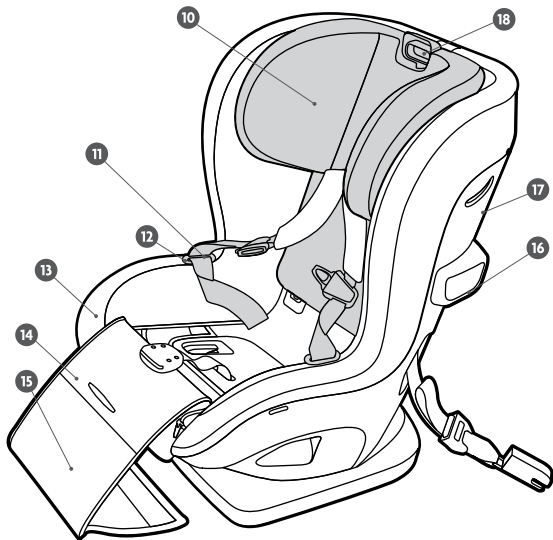

- 10** Active Support Headrest
- 11** Harness Strap
- 12** Buckle Tongue Holder
- 13** Seat Cover
- 14** Zip-Out Fabric Seat Cover
- 15** Instruction Manual Storage
- 16** Side Impact Pods
- 17** Recline Position Indicator
- 18** Headrest Adjuster

FEATURES OVERVIEW

- 19 Rear-Facing Belt Tensioning Plate
- 20 Rear-Facing Tensioning Clip
- 21 Tightness Indicators
- 22 Forward-Facing Belt Tensioning Plate
- 23 Forward-Facing Tensioning Clip

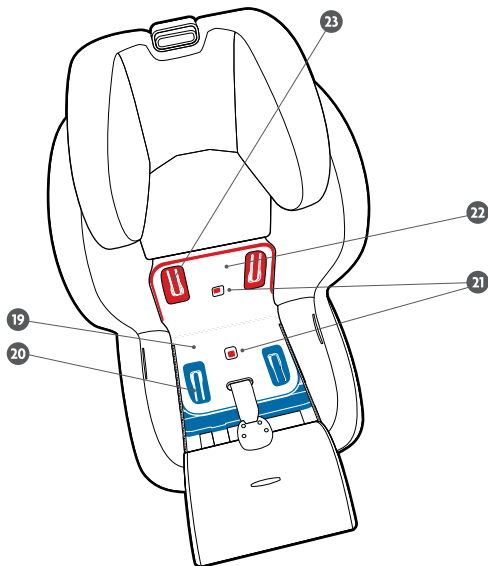

FEATURES OVERVIEW

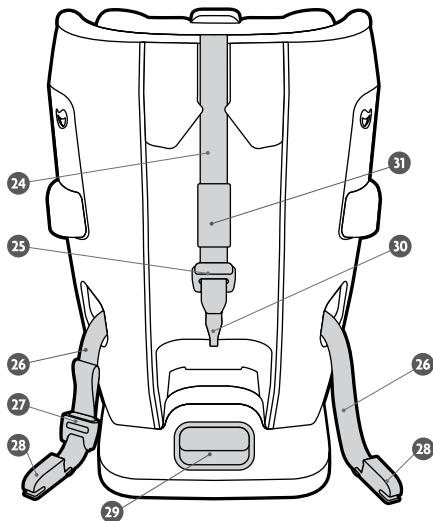

24 Multi-Directional Tether

25 Multi-Directional Tether Adjuster

26 Lower Anchor LATCH Connector Webbing

27 Lower Anchor LATCH Connector Adjuster

28 Lower Anchor LATCH Connector

29 Recline Adjustment Handle

30 Multi-Directional Tether Hook

31 Multi-Directional Tether Closure Sleeve

FEATURES OVERVIEW – Harness Usage

Loosen Harness

- 1 Loosen Harness by pressing Harness Release Button on front of Child Restraint **A** and pulling forward on both Harness Straps **B**.
- 2 Unbuckle Harness Straps by pressing button on Harness Buckle and pull out buckle tongues.
- 3 Open Retainer Clip by pressing button on clip and pulling apart.
- 4 Secure Buckle Tongues in storage pockets.

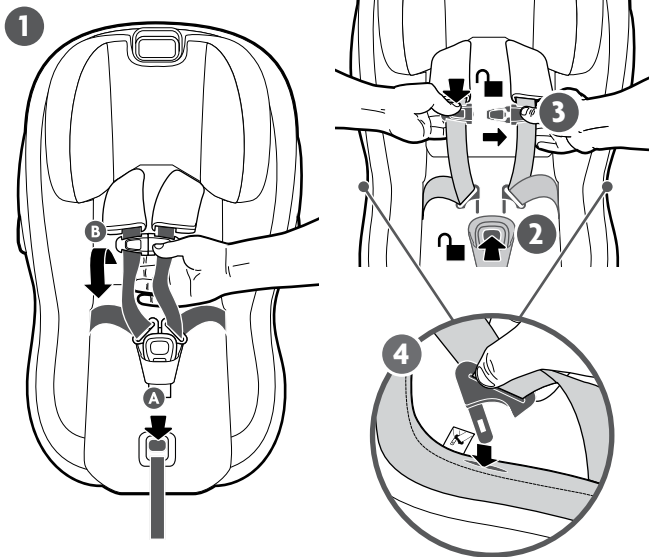

FEATURES OVERVIEW – Harness Usage

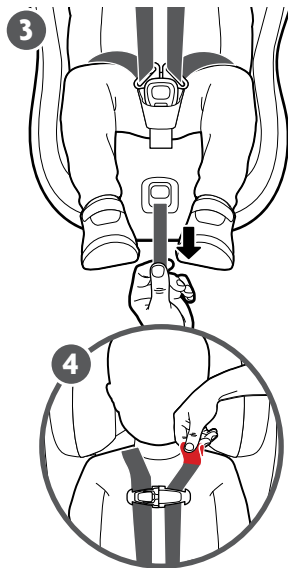
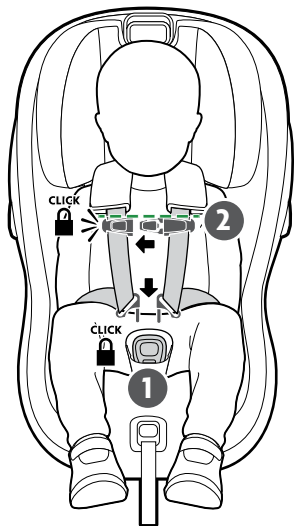

Tighten Harness

1 Insert Buckle Tongues into Harness Buckle until they click. Pull up on tongues to ensure they are locked.

2 To fasten Retainer Clip push together halves until they click. Pull to check.

NOTE: Top of Retainer Clip should be level with child's armpits.

3 To tighten harness pull Harness Adjuster Strap to recommended tightness.

4 Harness should be snug. Pinch harness webbing at child's shoulder (under shoulder pad). If you can pinch webbing, the harness is too loose and should be tightened.

NOTE: Harness pads are optional. Reference pg. 70 (Securing The Child) for additional information.

FEATURES OVERVIEW – Active Support Headrest Adjustment

The Active Support Headrest and harness provide advanced Side Impact Protection that grows with the child.

- 1 Loosen Harness (page 22).
- 2 Squeeze the Headrest Adjuster and move the headrest up or down to the desired position. The harness will travel up or down with the headrest.

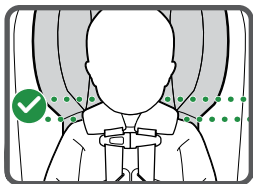
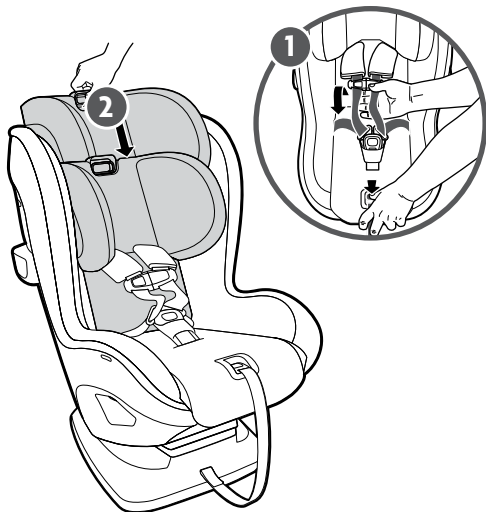

The headrest should be positioned at the child's shoulders to ensure proper fit of the harness. The headrest can lightly touch the shoulders and allow at most a fingertip of space between child's shoulders and headrest.

FEATURES OVERVIEW – Fit Inlay

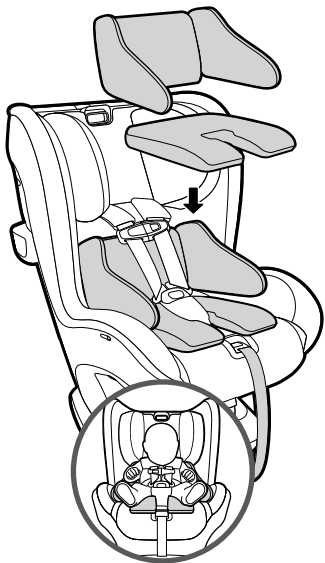

The Fit Inlay should be used for a child between 14 and 25 lbs (6.4–11.3 kg) in order to achieve a proper harness fit.

The headrest should be positioned at the child's shoulders to ensure proper fit of the harness. The headrest can lightly touch the shoulders and allow at most 1" of space between child's shoulders and headrest.

- 1 Place Fit Inlay in seat and pull harness buckle and cover through slot in bottom of insert.
- 2 Push Fit Inlay firmly into Child Restraint.

Remove the Fit Inlay at **25 lbs (11.3 kg)** or when the child begins growing on top of the buckle making it difficult to buckle the harness. The Fit Inlay has a two-piece construction. If the child is less than 25 lbs, first remove the Fit Inlay Back Cushion/Side Wings and retighten the harness. If still tight around the child's thighs remove the Fit Inlay completely.

FEATURES OVERVIEW – Cup Holder Usage

TO ATTACH THE CUP HOLDER:

Push cup holder stem into designated slot in side of Child Restraint.

TO REMOVE THE CUP HOLDER:

Pull firmly.



⚠ WARNING: DO NOT place glass, metal containers or hard sharp objects in cup holder as they could become a projectile in a crash and cause serious injury. **NEVER** put a hot liquid in the cup holder.

FEATURES OVERVIEW – Rear-Facing and Forward-Facing Belt Tensioning Plates

This Child Restraint has a **BLUE BELT TENSIONING PLATE** to be used for **REAR-FACING INSTALLATION** and a **RED BELT TENSIONING PLATE** to be used for **FORWARD-FACING INSTALLATION**.

The Belt Tensioning Plates feature robust vehicle belt tensioning clips enabling a tight installation and SMARTSecure visual indicator windows that turn from **RED** to **GREEN** when correct installation has been achieved.

NOTE: The SMARTSecure **RED** to **GREEN** indicator is a guide for confirming a tight installation. As all vehicle makes and models are different, it is possible that a tight installation has been achieved even though the window is not fully green. Always assess the install by checking at the belt path that the seat does not move more than 1" side to side or front to back in the vehicle seat.

TO ACCESS EITHER BELT POSITIONING PLATE:

- 1 Loosen harness (page 22).
- 2 Raise the Active Support Headrest to highest position (page 24).
- 3 Unzip fabric seat pad for better access and fold over towards the front of the seat.

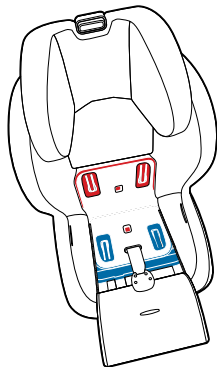
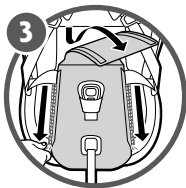
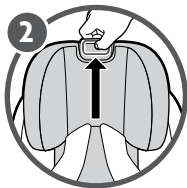
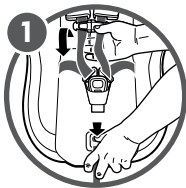

FEATURES OVERVIEW – LATCH Setup

TO ACCESS LOWER ANCHOR CONNECTORS:

- 1 To access Lower Anchor Connectors unsnap fabric over front panel of Child Restraint. Open the storage compartment and pull out the Lower Anchor Connectors.
- 2 Lengthen the Lower Anchor Connector to maximize length by pushing the Lower Anchor Connector Adjuster Button and pulling to full extension.
- 3 Loosen harness.
- 4 Raise headrest to maximum height.
- 5 Unzip the fabric seat and expose the **REAR-FACING** or **FORWARD-FACING** belt path.

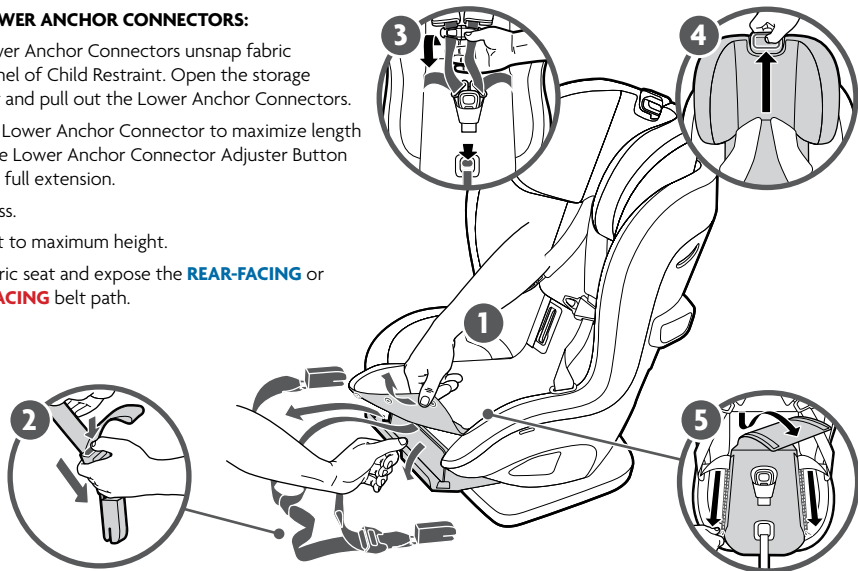

FEATURES OVERVIEW – LATCH Setup

- 6 Route Lower Anchor Connectors and Belt under fabric seat pad from front of seat aligning webbing with **FORWARD-FACING** or **REAR-FACING** belt path.

NOTE: Slide Belt tether loop to side to not interfere with LATCH installation.

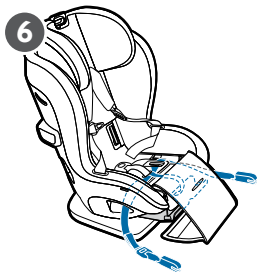

REAR-FACING LATCH INSTALLATION (page 46)
14–30 lbs (6.4–13.6 kg)

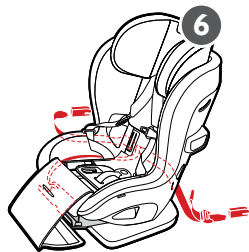

FORWARD-FACING LATCH INSTALLATION (page 62)
Not preferred method for forward-facing installation
25–35 lbs (11.3–15.9 kg)

⚠ WARNING: DO NOT use the Lower Anchorage System (LATCH) to attach this Child Restraint when restraining a child weighing more than **30 lbs (13.6 kg)** for Rear-Facing installation and **35 lbs (15.9)** for Forward-Facing installation.

FEATURES OVERVIEW – LATCH Use and Storage

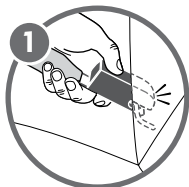

1 LOCK To connect Lower Anchor Connectors to Lower Anchors in vehicle, push connector onto lower anchor until you hear a click. Pull to confirm attachment.

NOTE: DO NOT *push the red button.*

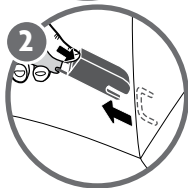

2 RELEASE To release Lower Anchor Connectors, press red button at end of connector and pull to detach.



3 STORE To store, fold Lower Anchor Connector and place into storage compartment, tucking away excess webbing. Close door until firmly in place. Snap fabric onto panel.

When not in use, the Lower Anchor Connectors **MUST** be properly secured in the dedicated storage compartment under the front leg rest portion of the Child Restraint.

⚠ WARNING: DO NOT use LATCH to attach this Child Restraint when restraining a child weighing more than **30 lbs (13.6 kg)** for Rear-Facing installation and **35 lbs (15.9)** for Forward-Facing installation. Please refer to your vehicle owner's manual for LATCH information.

FEATURES OVERVIEW – Multi Directional Tether Use and Storage

UPPABABY STRONGLY RECOMMENDS USING THE MULTI-DIRECTIONAL TETHER for both **FORWARD-FACING** and **REAR-FACING** installations if vehicle is equipped with a tether anchor point and vehicle requirements are met (See Vehicle Owner's Manual).

REAR-FACING MULTI-DIRECTION TETHER INSTALLATION (page 50)



Route the webbing either through the vehicle headrest posts or if an integrated headrest exists, to the same side you routed the tether.

FORWARD-FACING MULTI-DIRECTIONAL TETHER INSTALLATION (page 66)

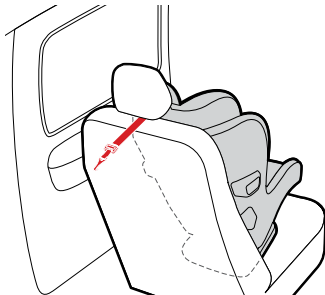

Route the webbing either through the vehicle headrest posts or if an integrated headrest exists, over the top of the headrest.

FEATURES OVERVIEW – Multi Directional Tether Use and Storage

USING THE MULTI-DIRECTIONAL TETHER

- 1 Unhook the Multi-Directional Tether located on the back side of the Child Restraint.
- 2 To lengthen the strap, push the Multi-Directional Tether Adjuster button and pull.

NOTE: Maximize length of tether before Rear and Forward-Facing installations.

- 3 The Multi-Directional Tether webbing is intentionally long. Once attached, roll the excess webbing around the fabric sleeve and secure.

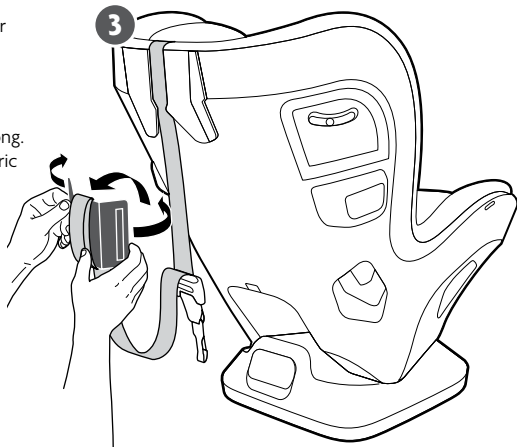
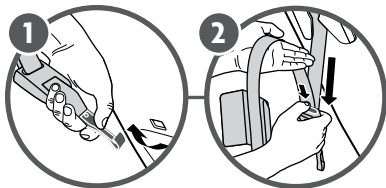

FEATURES OVERVIEW – Multi Directional Tether Use and Storage

STORING THE MULTI-DIRECTIONAL TETHER WHEN NOT IN USE

- 1 Attach Multi-Directional Tether to storage anchor.
- 2 Remove slack in strap by pulling on free end of strap.

NOTE: Make sure the webbing is not twisted.

- 3 Loose strap **MUST** be rolled around the fabric closure and secured.

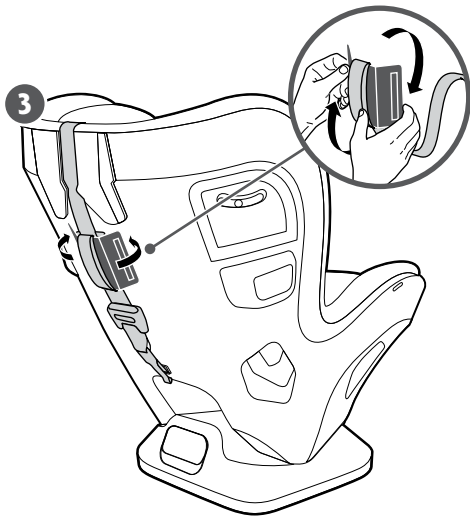
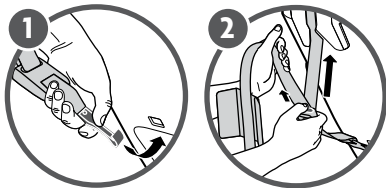

When not in use, the Multi-Directional Tether **MUST** be stored properly.

FEATURES OVERVIEW – Recline Adjustment

This Child Restraint has 4 recline positions. Recline can be changed for child's comfort or to improve installation of Child Restraint.

TO ADJUST THE RECLINE: Pull the Recline Adjustment Handle located on the back of Child Restraint upward and move the seat to the desired recline position.

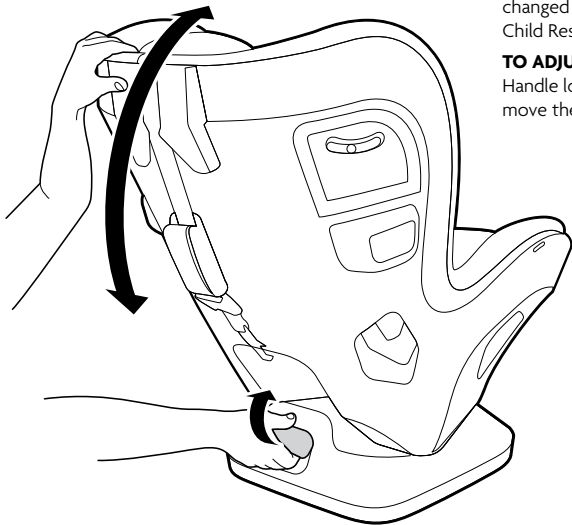

FEATURES OVERVIEW – Recline Adjustment

REAR-FACING INSTALLATION

14–45 lbs (6.4–20.4 kg)



ALWAYS check the Recline Position Indicator and adjust the recline so that the bead is between the correct **BLUE** area for **REAR-FACING INSTALLATION**.

FORWARD-FACING INSTALLATION

25–65 lbs (11.3–29.5 kg)

RECLINE POSITIONS 1/2



For **FORWARD-FACING INSTALLATION** with children:
25–45 lbs recline the seat to **POSITION 1 OR 2**
45–65 lbs the seat must be in the **FULL UPRIGHT POSITION**

REAR-FACING INSTALLATION

14–45 lbs (6.4–20.4 kg)



← **VEHICLE BELT** (14–45 lbs) →

← **LATCH** (14–30 lbs) →

← **FIT INLAY** (14–25 lbs) →

14 lbs
(6.4 kg)

25 lbs
(11.3 kg)

30 lbs
(13.6 kg)

45 lbs
(20.4 kg)

REAR-FACING INSTALLATION – Setup

This Child Restraint has **4 recline positions**. Recline can be changed to improve installation of this Child Restraint and for child comfort. The Fit Inlay should be used with children 14–25 lbs (6.4–11.3 kg) to improve the recline angle.

- 1 Place Child Restraint on vehicle seat in the **REAR-FACING** direction as shown. Ensure the bottom surface is flush against the vehicle seat without any gapping or tilting.
- 2 To adjust recline, pull the Recline Adjustment Handle upward and move the seat to the desired recline position.
- 3 Slide Child Restraint towards the back of the vehicle seat until it makes contact with the vehicle seat back.

NOTE: 80% of the base should be in contact with the vehicle cushion.

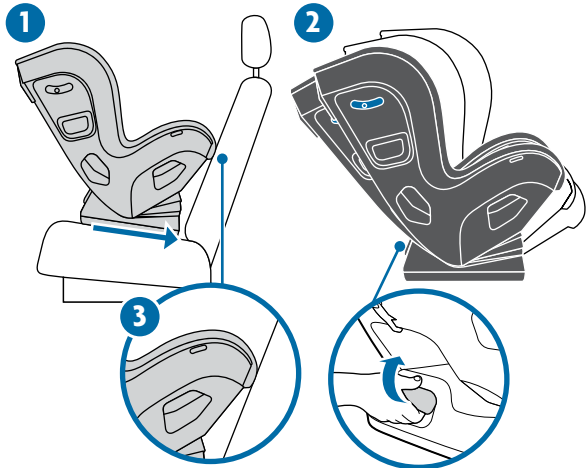

REAR-FACING INSTALLATION – Setup

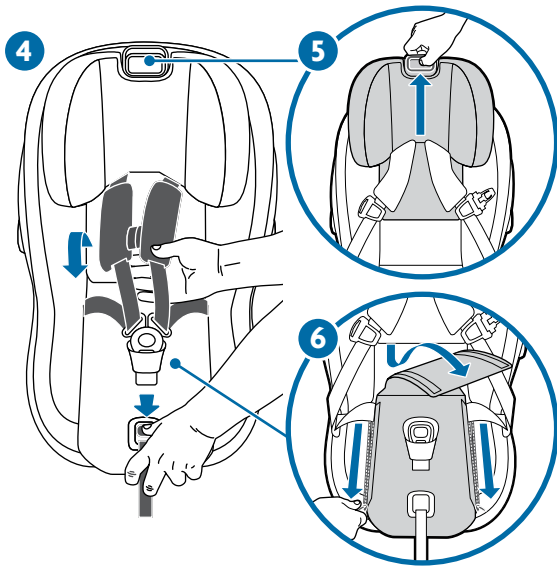

- 4 Loosen harness by pressing the Harness Release Button and pulling harness forward. Unbuckle harness.
- 5 Raise Headrest by squeezing the Headrest Adjuster as shown and upward to allow access for installation.
- 6 Unzip fabric panel to expose the **BLUE REAR-FACING** Belt Tensioning Plate (page 27).

To complete **REAR-FACING** installation, please refer to:

LAP/SHOULDER BELT PAGE 42

LAP BELT ONLY PAGE 44

LATCH PAGE 46

REAR-FACING INSTALLATION – Vehicle Seat Recline

Some cars may have a different type of seat that is more angled or sloped. In this instance, it may be more difficult to achieve the proper recline angle.

In order to achieve proper recline and get the bead in the correct **BLUE** area for **REAR-FACING INSTALLATION**, you may need to use a folded towel under the base in the seat bight (crease of seat).

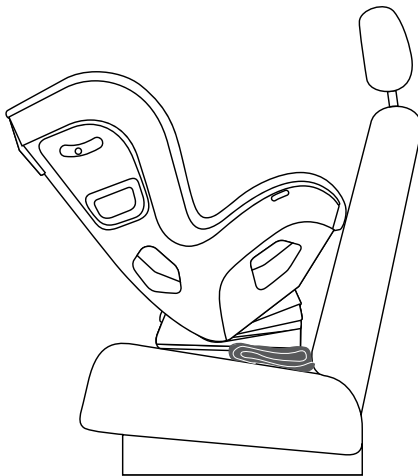

REAR-FACING INSTALLATION – Vehicle Seat Recline

This is an easy issue to resolve by following the steps below:

- 1 Uninstall your KNOX
- 2 Place a folded hand towel under the KNOX against the seat bight (crease of seat). You may need to adjust number of folds to achieve the proper recline.
- 3 Once the bead is in the correct **BLUE** area for **REAR-FACING INSTALLATION**, proceed with installation. Follow Safety Check (pg. 53) to confirm proper steps.

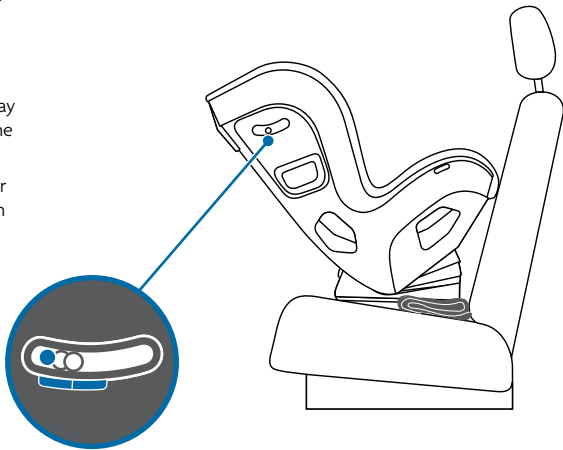

REAR-FACING INSTALLATION – Lap/Shoulder Belt Use

- 1 Route vehicle lap/shoulder belt through the **REAR-FACING BLUE** belt path and buckle.
- 2 Ensuring there is no twisting in the vehicle belt, route the lap belt **ONLY** under the **BLUE REAR-FACING** Tensioning Plate.
- 3 Apply pressure into the seat bight and pull up on the vehicle shoulder belt to remove all slack.

NOTE: As pressure is applied, the Tightness Indicator window will turn from **RED** to **GREEN**. It is possible to achieve a tight installation even if the indicator is not fully green. Always check belt path for no more than 1" movement.

- 4 Holding the shoulder belt taut to ensure no slack is introduced back into the vehicle belt, route the shoulder belt under both tensioning clips.

NOTE: The shoulder belt **MUST** route fully under the tensioning clip furthest away from the buckle for a secure installation. However, due to the angle of some vehicle belts, if the shoulder belt closest to the buckle does not slip fully under the clip, you will still be able to achieve a proper installation.

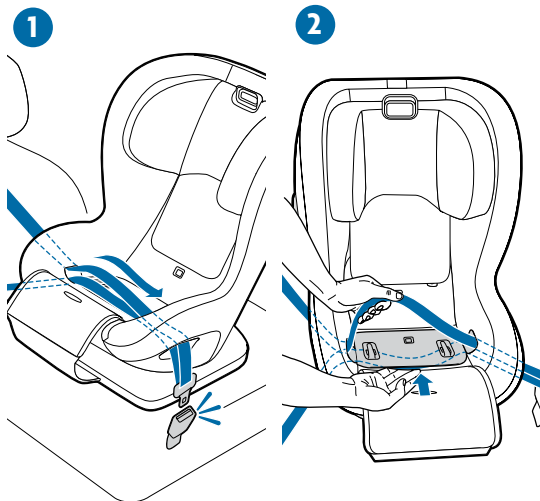

REAR-FACING INSTALLATION – Lap/Shoulder Belt Use

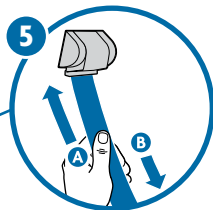
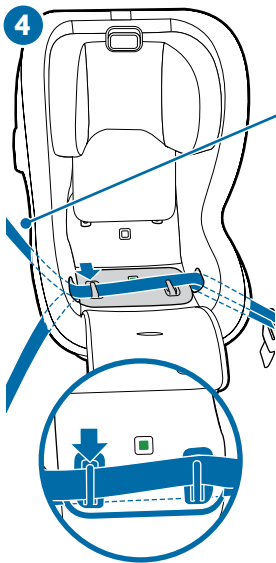
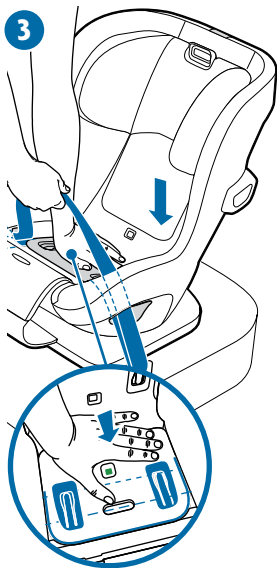

- 5 Lock the vehicle belt by pulling it all the way out, switching the retractor into ALR mode. Feed the slack back into the retractor to remove any slack. Check your vehicle's owner manual for additional information on locking the belt.

PROCEED TO PAGE 50 FOR
MULTI-DIRECTIONAL TETHER USAGE.

REVIEW SAFETY CHECK ON PAGE 53.
ALL STEPS MUST BE ACHIEVED BEFORE
MOVING FORWARD.

REAR-FACING INSTALLATION – Lap Belt Only Use

- 1 Route lap belt through the **BLUE REAR-FACING** belt guides and buckle.
- 2 Ensuring there is no twisting in the vehicle belt, route the lap belt under the **BLUE REAR-FACING** Tensioning Plate.

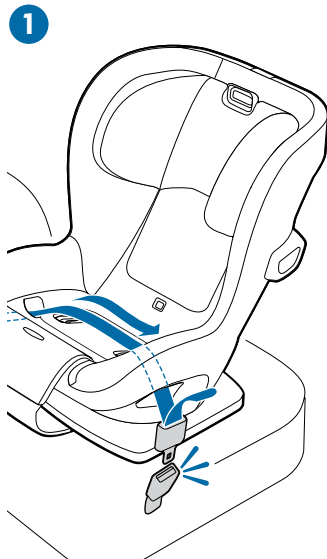

REAR-FACING INSTALLATION – Lap Belt Only Use

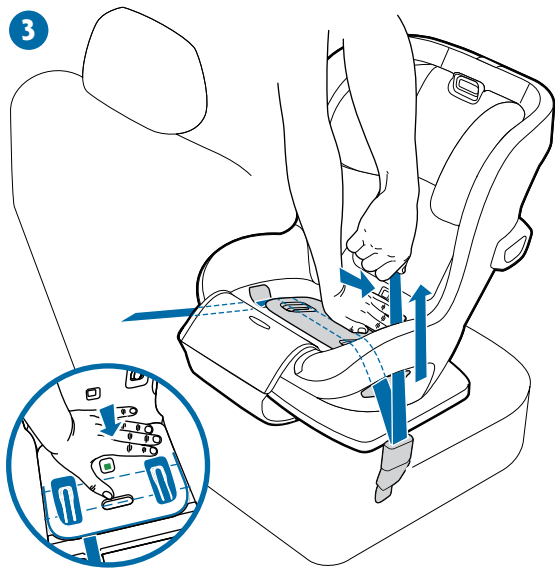

- 3 Apply pressure into seat bight and pull up on belt to remove all slack.

NOTE: As pressure is applied, the Tightness Indicator window will turn from **RED** to **GREEN**. It is possible to achieve a tight installation even if the indicator is not fully green. Always check belt path for no more than 1" movement.

PROCEED TO PAGE 50 FOR
MULTI-DIRECTIONAL TETHER USAGE.

REVIEW SAFETY CHECK ON PAGE 53.
ALL STEPS MUST BE ACHIEVED BEFORE
MOVING FOWARD.

REAR-FACING INSTALLATION – LATCH Setup

ATTENTION: This Child Restraint cannot be installed using lower anchors (LATCH) for rear-facing installation when your child exceeds 30 lbs (13.6 kg). If your child weights over 30 lbs (13.6 kg) the vehicle belt **MUST** be used for installation. Installation with LATCH and vehicle seat belt are not permitted together.

TO ACCESS LOWER ANCHOR CONNECTORS

- 1 Remove the front section of fabric and slide the Lower Anchor Connectors under the fabric and along the plastic indent at front of seat.
- 2 Make sure the Lower Anchor Connector Belt is not twisted. Route the belt under the **BLUE REAR-FACING** Tensioning Plate.
- 3 Raise headrest to maximum height
- 4 Unzip the fabric seat and expose the **REAR-FACING** belt path.

Use of lower anchors in the rear center seating position must be approved by the vehicle manufacturer and may be up to 22". If spacing is greater than 22" or if the seating position is not approved by the vehicle manufacturer, then use the vehicle seat belt for installation.

REAR-FACING INSTALLATION – LATCH Setup

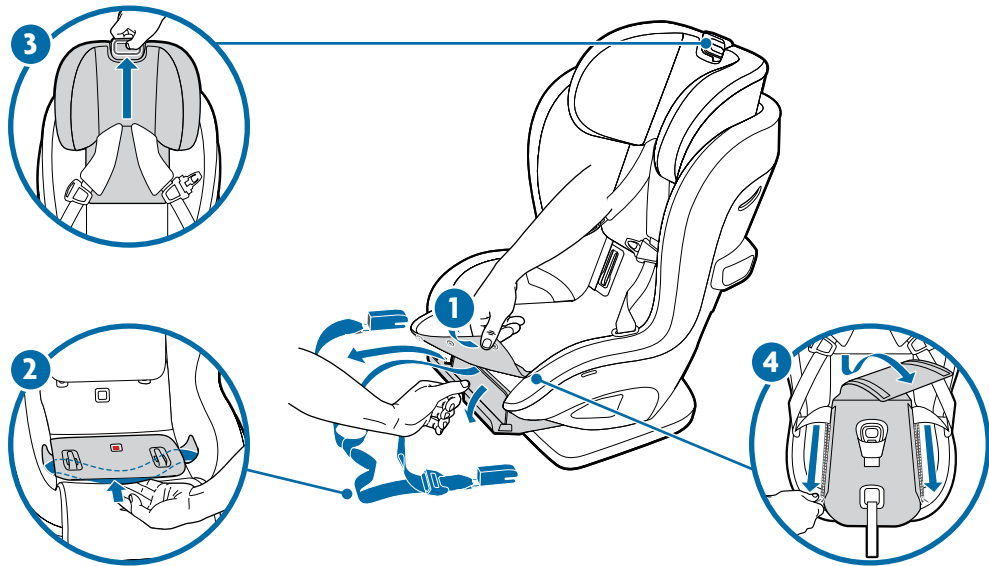

REAR-FACING INSTALLATION – LATCH Use

- 1 Unsnap the front section of fabric and slide Lower Anchor Connectors under the fabric and through the **BLUE REAR-FACING** Belt Path.
- 2 Make sure the Lower Anchor Connector Belt is not twisted. Route the belt under the **BLUE REAR-FACING** Tensioning Plate.
NOTE: To get more length in the Lower Anchor Connector Webbing, press the adjuster and pull the belt.
- 3 Route the Lower Anchor Connectors through the respective left and right **BLUE** belt paths and under the **BLUE REAR-FACING** tensioning plate.
- 4 Attach Connectors to the Lower Anchors (LATCH) in vehicle.

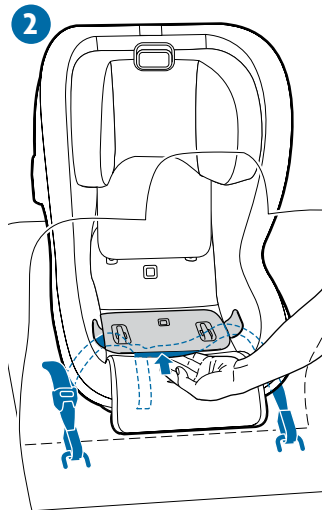
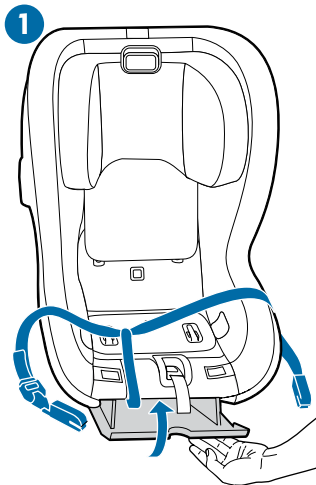

REAR-FACING INSTALLATION – LATCH Use

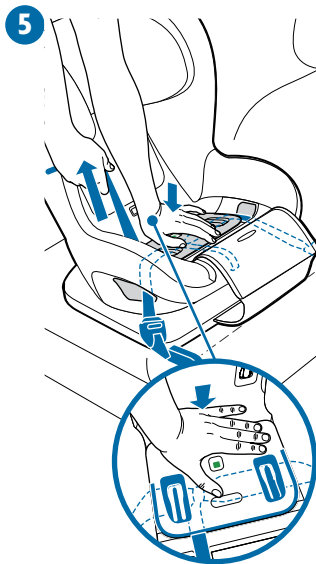
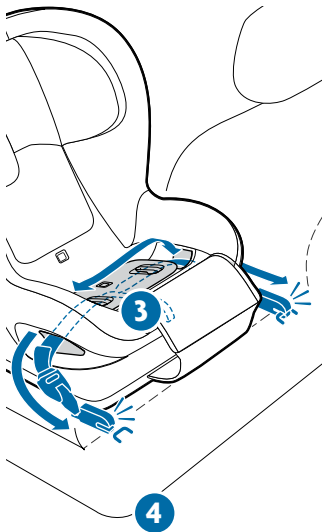

- 5 Apply pressure into seat bight and pull up on Lower Anchor Adjuster to remove all slack.

NOTE: As pressure is applied, the Tightness Indicator window will turn from **RED** to **GREEN**. It is possible to achieve a tight installation even if the indicator is not fully green. Always check belt path for no more than 1" movement.

PROCEED TO PAGE 50 FOR
MULTI-DIRECTIONAL TETHER USAGE.

REVIEW SAFETY CHECK ON PAGE 53.
ALL STEPS MUST BE ACHIEVED
BEFORE MOVING FORWARD.

REAR-FACING INSTALLATION – Rear-Facing Tether Use

ATTENTION: IT IS STRONGLY RECOMMENDED to utilize the Multi-Directional Tether for **REAR-FACING** installation if vehicle is equipped with a Tether Anchor point and vehicle requirements are met. The tether will improve the stability of your Child Restraint and reduce the risk of injury. See your vehicle owner's manual for approved anchor locations.

- 1 Route the Multi-Directional Tether through the guide located on the back of the seat as shown. It is recommended to route the webbing either through the vehicle headrest posts or if an integrated headrest exists, to the same side you routed the tether.
- 2 Route the webbing either through the vehicle headrest posts or, if an integrated headrest exists, to the inboard side of the headrest.
- 3 Hook the Multi-Directional Tether to an approved vehicle Tether (LATCH) location. Please refer to your vehicle owner's manual.
- 4 Pull up on the strap as shown until the webbing is taut.
- 5 Excess webbing **MUST** be rolled around the fabric sleeve and secured with closure provided.

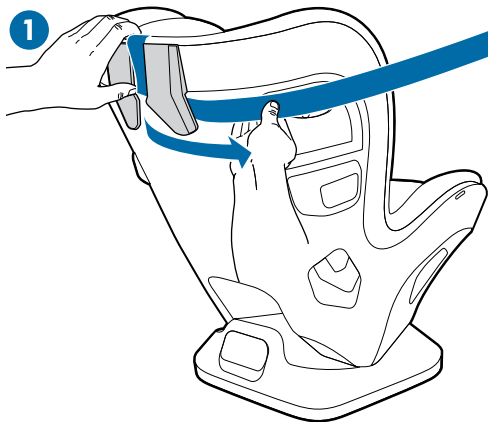

REAR-FACING INSTALLATION – Rear-Facing Tether Use

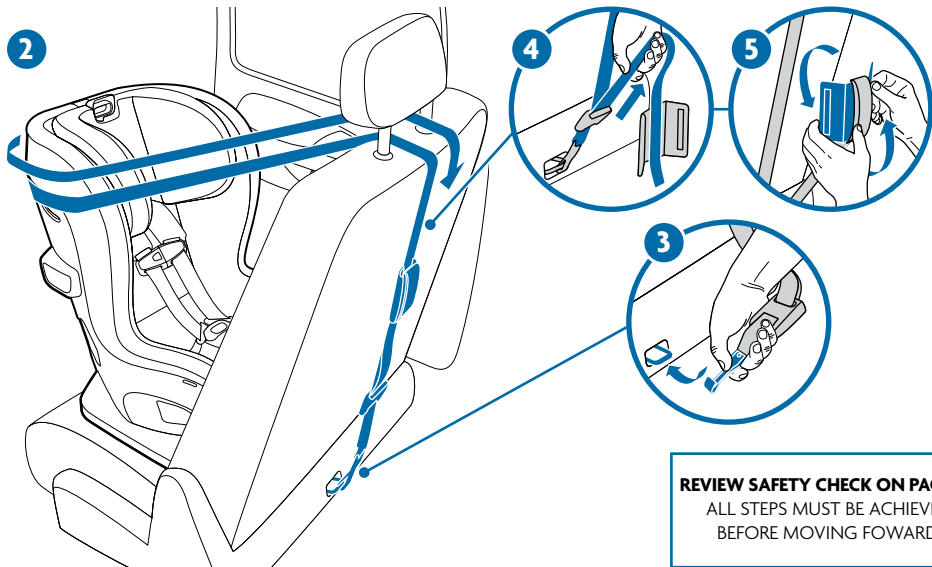

REAR-FACING INSTALLATION – Aircraft Use



CERTIFIED FOR AIRCRAFT TRAVEL: THIS CHILD SEAT IS CERTIFIED FOR AIRCRAFT USE. THE FAA RECOMMENDS THAT A CHILD WEIGHING UP TO 40 LBS (18 KG) USE A CERTIFIED, HARNESSSED CHILD SEAT WHILE TRAVELING ON AN AIRCRAFT. CONTACT THE AIRLINE ABOUT THEIR POLICY PRIOR TO TRAVELING.

FOR REAR-FACING AIRCRAFT INSTALLATION:

- 1 Recline this child seat and place **REAR-FACING** on the aircraft seat.
- 2 Route the aircraft lap belt through the **REAR-FACING BLUE** belt path and buckle. It is not required to route the belt under the Belt Tensioning Plate.
- 3 Ensure the lap belt is not twisted.
- 4 Remove all slack to secure child seat in airline seat.

SAFETY REMINDERS AND TIPS

- This seat may not fit all aircrafts. Contact your airline prior to travel to verify fit.
- Install your child seat in a window seat to avoid blocking the aisle.
- If the aircraft lap belt is too short, ask a flight attendant for a belt extender.
- In some cases your child may experience discomfort if the buckle is located in the seating area of the child seat after installation. If possible, it is acceptable to route the seat belt behind the Belt Tensioning Plate.
- Inflatable aircraft lap belts are not compatible with this child seat.

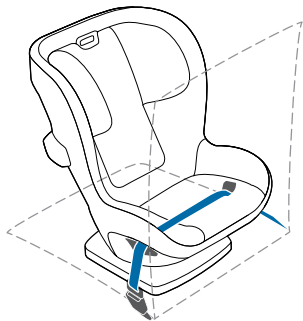

REAR-FACING INSTALLATION – Safety Check

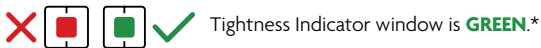

CHECK AT THE BELT PATH to ensure there is not more than 1" of movement side to side or front to back. If there is more than 1" of movement, repeat installation steps.

For lap belt only and lap/shoulder belt installations, make sure the vehicle lap belt is routed under belt plate and for lap/shoulder belt installations only, make sure the shoulder belt is fully secured under the tensioning clip. Check vehicle belt retractor is locked for lap/shoulder belt installations.



ALWAYS check the Recline Position Indicator. The bead should be between the correct **BLUE** area for **REAR-FACING INSTALLATION**.

Occasionally check Child Restraint for tightness in the belt path and lift the fabric panel to ensure Tightness Indicator remains **GREEN. It is possible to achieve a tight installation even if the indicator is not fully green. Always check belt path for no more than 1" movement.*

FORWARD-FACING INSTALLATION

25–65 lbs (11.3–29.5 kg)



← **VEHICLE BELT** (25–65 lbs) →
← **LATCH** (25–35 lbs) →



FORWARD-FACING INSTALLATION – Setup

- 1 Place Child Restraint on vehicle seat in **FORWARD-FACING** direction as shown. Ensure the bottom surface is in full contact with the vehicle seating surface.
- 2 Confirm for **FORWARD-FACING** installation that the seat is reclined as follows:
 - **25–45 lbs** recline the seat to **POSITION 1 or 2**
 - **45–65 lbs** the seat must be in the **FULL UPRIGHT POSITION**.
- 3 Slide Child Restraint towards back of vehicle seat until contact is made with vehicle seat back.
- 4 Loosen harness by pressing the Harness Release Button and pulling harness forward. Unbuckle harness.
- 5 Raise headrest by squeezing the Headrest Adjuster as shown then pull upward to allow access to the **RED FORWARD-FACING** Belt Tensioning Plate.



NOTE: At least 80% of the base should cover the vehicle cushion.

FORWARD-FACING INSTALLATION – Setup

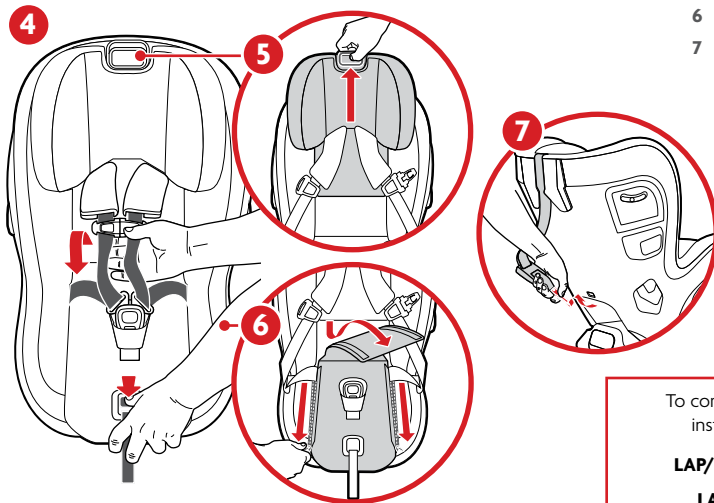

- 6 Unfasten then unzip fabric panel.
- 7 Remove Multi-Directional Tether from storage, lengthen webbing and place on front side of the seat prior to installation (page 31).

To complete **FORWARD-FACING** installation, please refer to:

LAP/SHOULDER BELT PAGE 58

LAP BELT ONLY PAGE 60

LATCH PAGE 62

FORWARD-FACING INSTALLATION – Lap/Shoulder Belt Use

PLACE MULTI-DIRECTIONAL TETHER ON FRONT SIDE OF THE SEAT PRIOR TO INSTALLATION.

- 1 Route vehicle lap/shoulder belt through the **RED FORWARD-FACING** belt path and buckle
- 2 Ensuring there is no twisting in the vehicle belt, route the lap belt **ONLY** behind the **RED FORWARD-FACING** Tensioning Plate.
- 3 Apply pressure into the seat bight and pull up on the vehicle shoulder belt to remove all slack.

NOTE: As pressure is applied, the Tightness Indicator window will turn from **RED** to **GREEN**. It is possible to achieve a tight installation even if the indicator is not fully green. Always check belt path for no more than 1" movement.

- 4 Holding the shoulder belt taut to ensure no slack is introduced back into the vehicle belt, route the shoulder belt under both tensioning clips.

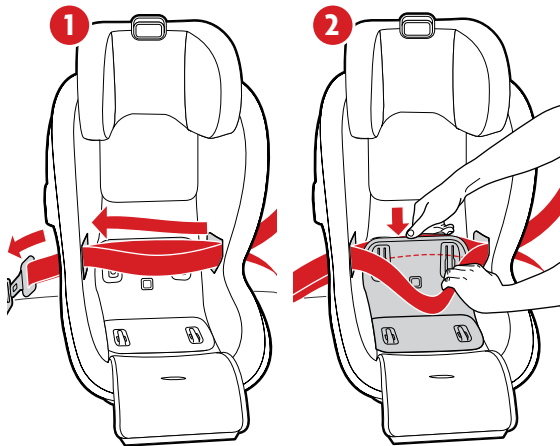

NOTE: The shoulder belt **MUST** route fully under the tensioning clip furthest away from the buckle for a secure installation. However, due to the angle of some vehicle belts, if the shoulder belt closest to the buckle does not slip fully under the clip, you will still be able to achieve proper installation.

FORWARD-FACING INSTALLATION – Lap/Shoulder Belt Use

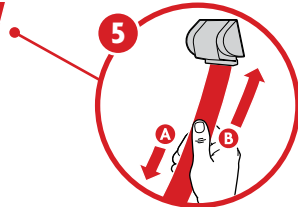
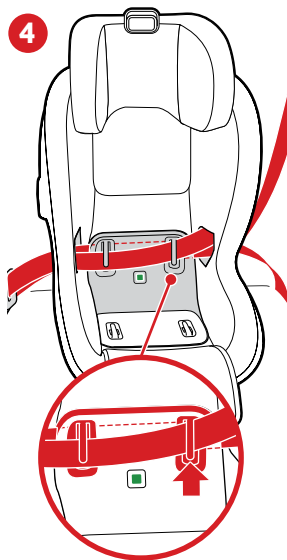
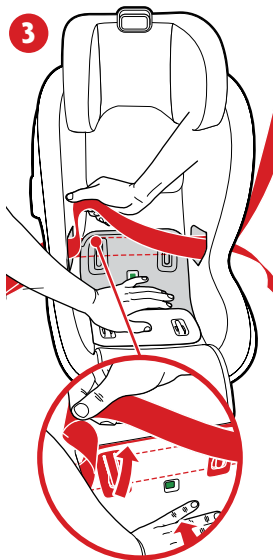

- 5 Lock the vehicle belt by pulling it all the way out, switching the retractor into ALR mode **A**. Feed the slack back into the retractor to remove any slack **B**. Check your vehicle's owner manual for additional information on locking the belt.

PROCEED TO PAGE 66 FOR
MULTI-DIRECTIONAL TETHER USAGE.

REVIEW SAFETY CHECK ON PAGE 69.
ALL STEPS MUST BE ACHIEVED BEFORE
MOVING FORWARD.

FORWARD-FACING INSTALLATION – Lap Belt Only Use

- 1 Route lap belt through the **RED FORWARD-FACING** belt path and buckle.
- 2 Ensuring there is no twisting in the vehicle belt, route the lap belt behind the **RED FORWARD-FACING** Tensioning Plate.
- 3 Apply pressure into seat bight and pull up on belt to remove all slack.

NOTE: As pressure is applied, the Tightness Indicator Window will turn from **RED** to **GREEN**. It is possible to achieve a tight installation even if the indicator is not fully green. Always check belt path for no more than 1" movement.

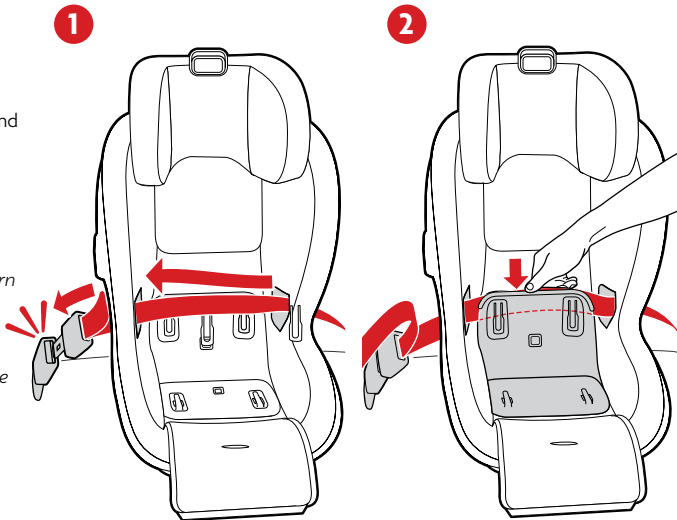

FORWARD-FACING INSTALLATION – Lap Belt Only Use

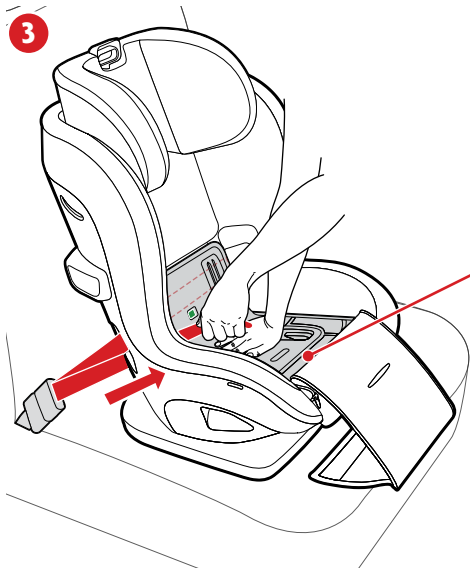

PROCEED TO PAGE 66 FOR
MULTI-DIRECTIONAL TETHER USAGE.

REVIEW SAFETY CHECK ON PAGE 69.
ALL STEPS MUST BE ACHIEVED
BEFORE MOVING FOWARD.

FORWARD-FACING INSTALLATION – LATCH Setup

ATTENTION: THIS CHILD RESTRAINT CANNOT BE INSTALLED USING LOWER ANCHORS (LATCH) FOR FORWARD-FACING INSTALLATION WHEN YOUR CHILD EXCEEDS 35 LBS (15.9 KG). IF YOUR CHILD WEIGHS OVER 35 LBS (15.9 KG) THE VEHICLE BELT MUST BE USED FOR INSTALLATION.

TO ACCESS LOWER ANCHOR CONNECTORS

- 1 To access Lower Anchor Connectors unsnap fabric over front panel of Child Restraint. Open the storage compartment and pull out the Lower Anchor Connectors.
- 2 Lengthen the Lower Anchor Connector to maximize length by pushing the Lower Anchor Connector Adjuster Button and pulling to full extension.
- 3 Raise headrest to maximum height.
- 4 Unfasten then unzip the fabric seat and expose the **FORWARD-FACING** belt path.

FORWARD-FACING INSTALLATION – LATCH Setup

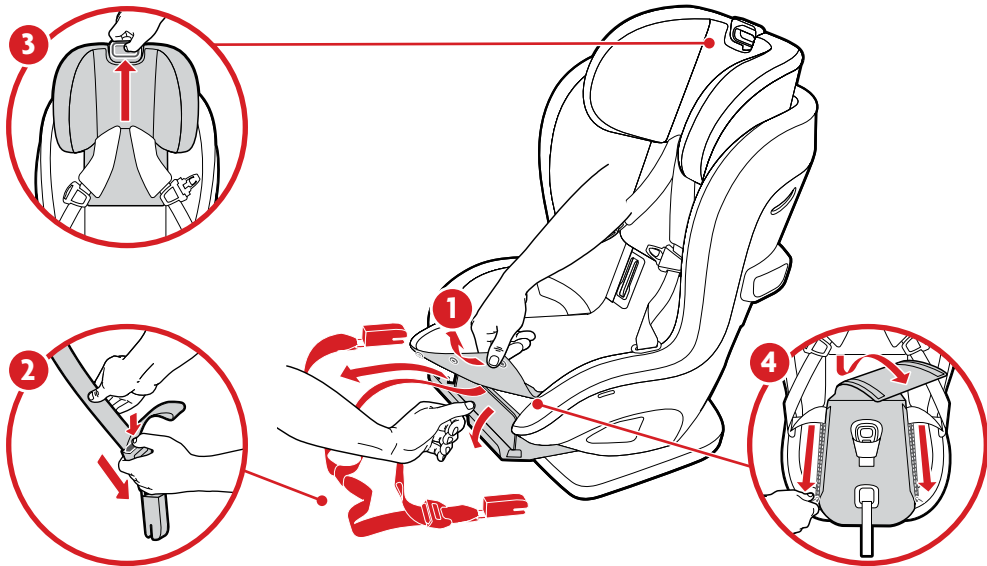

FORWARD-FACING INSTALLATION – LATCH Use

ATTENTION: THIS CHILD RESTRAINT CANNOT BE INSTALLED USING LOWER ANCHORS (LATCH) FOR FORWARD-FACING INSTALLATION WHEN YOUR CHILD EXCEEDS 35 LBS (15.9 KG). IF YOUR CHILD WEIGHS OVER 35 LBS (15.9 KG) THE VEHICLE BELT MUST BE USED FOR INSTALLATION.

NOTE: To get more length in the Lower Anchor Connector Webbing, press the adjuster and pull the belt.

- 1 Remove the front section of fabric and slide Lower Anchor Connectors under the fabric toward the **RED FORWARD-FACING** Belt Path.
- 2 Make sure the Lower Anchor Connector Belt is not twisted. Route the belt behind the **RED FORWARD-FACING** Tensioning Plate.

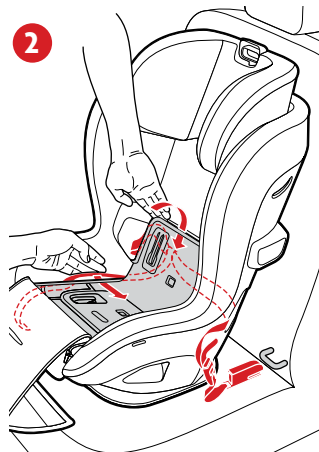
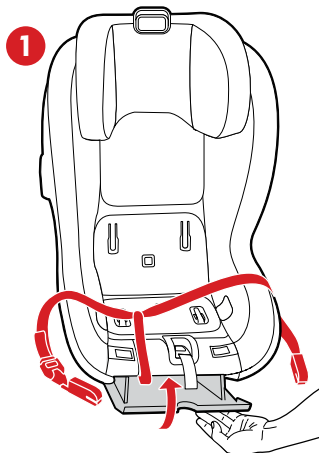

FORWARD-FACING INSTALLATION – LATCH Use

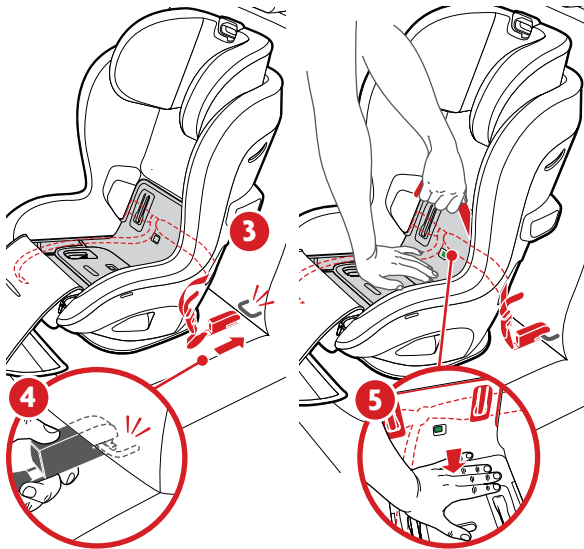

- 3 Route the Lower Anchor Connectors through the respective left and right **RED** belt paths.
 - 4 Attach to Lower Anchors (LATCH) in vehicle. Listen for an audible click.
 - 5 Apply pressure into seat bight and pull up on belt to remove all slack.
- NOTE:** As pressure is applied, the Tightness Indicator window will turn from **RED** to **GREEN**. It is possible to achieve a tight installation even if the indicator is not fully green. Always check belt path for no more than 1" movement.
- 6 Snap the front section of fabric closed.

PROCEED TO PAGE 66 FOR
MULTI-DIRECTIONAL TETHER USAGE.

REVIEW SAFETY CHECK ON PAGE 69.
ALL STEPS MUST BE ACHIEVED
BEFORE MOVING FORWARD.

FORWARD-FACING INSTALLATION – Forward-Facing Tether Use

ATTENTION: IT IS STRONGLY RECOMMENDED to utilize the Multi-Directional Tether for **FORWARD-FACING** installation if vehicle is equipped with a Tether Anchor point and vehicle requirements are met. The tether will improve the stability of your Child Restraint and reduce the risk of injury. See your vehicle owner's manual for approved anchor locations.

- 1 Route the webbing either through the vehicle headrest posts or, if an integrated headrest exists, over the top of the headrest.
- 2 Hook the Multi-Directional Tether to an approved vehicle Tether (LATCH) location. Please refer to your vehicle owner's manual.
- 3 Pull up on the strap as shown until webbing is taut.
- 4 Excess webbing **MUST** be rolled around the fabric sleeve and secured with closure provided.

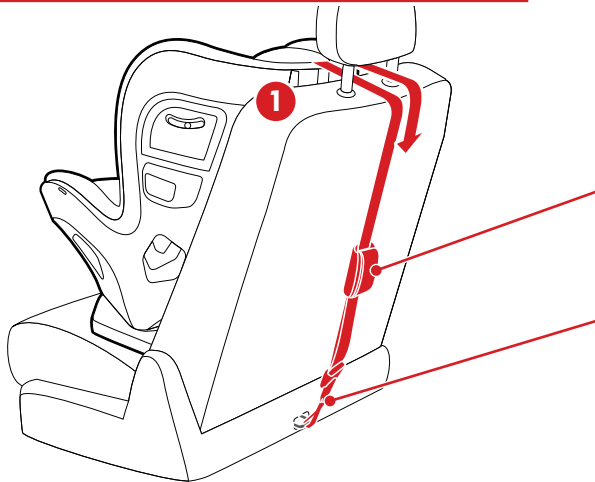

FORWARD-FACING INSTALLATION – Forward-Facing Tether Use

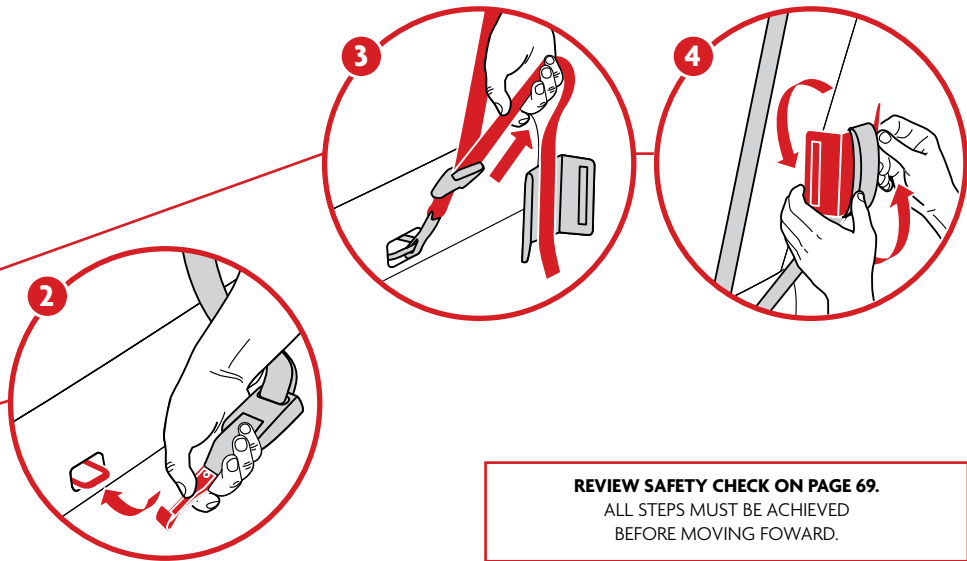

REVIEW SAFETY CHECK ON PAGE 69.

ALL STEPS MUST BE ACHIEVED
BEFORE MOVING FORWARD.

FORWARD-FACING INSTALLATION – Aircraft Use



CERTIFIED FOR AIRCRAFT TRAVEL: THIS CHILD SEAT IS CERTIFIED FOR AIRCRAFT USE. THE FAA RECOMMENDS THAT A CHILD WEIGHING UP TO 40 LBS (18 KG) USE A CERTIFIED, HARNESSSED CHILD SEAT WHILE TRAVELING ON AN AIRCRAFT. CONTACT THE AIRLINE ABOUT THEIR POLICY PRIOR TO TRAVELING.

FOR FORWARD-FACING AIRCRAFT INSTALLATION:

- 1 Place this child seat **FORWARD-FACING** on the aircraft seat in the upright position.
- 2 Route the aircraft lap belt over the **FORWARD-FACING RED** tensioning plate and buckle. Secure the belt under both tensioning clips to hold belt in place.
- 3 Ensure the lap belt is not twisted.
- 4 Remove all slack to secure child seat in airline seat.

SAFETY REMINDERS AND TIPS

- This seat may not fit all aircrafts. Contact your airline prior to travel to verify fit.
- Install your child seat in a window seat to avoid blocking the aisle.
- If the aircraft lap belt is too short, ask a flight attendant for a belt extender.
- In some cases your child may experience discomfort if the buckle is located in the seating area of the child seat after installation. If possible, it is acceptable to route the seat belt behind the Belt Tensioning Plate.
- Inflatable aircraft lap belts are not compatible with this child seat.

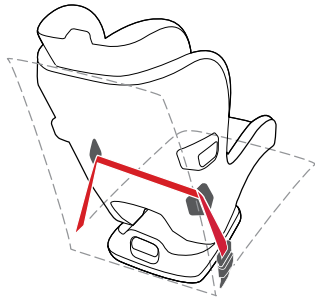

FORWARD-FACING INSTALLATION – Safety Check

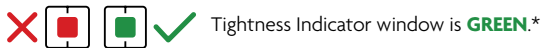

CHECK AT THE BELT PATH to ensure there is not more than 1" of movement side to side or front to back. If there is more than 1" of movement, repeat installation steps.

For lap belt only and lap/shoulder belt installations, make sure the vehicle lap belt is routed under belt plate and for lap/shoulder belt installations only, make sure the shoulder belt is fully secured under the tensioning clip. Check vehicle belt retractor is locked for lap/shoulder belt installations.

Confirm for **FORWARD-FACING** installation that the seat is reclined as follows:

25–45 lbs recline the seat to **POSITION 1 or 2**

45–65 lbs the seat must be in the **FULL UPRIGHT POSITION**

Occasionally check Child Restraint for tightness in the belt path and lift the fabric panel to ensure Tightness Indicator remains **GREEN. It is possible to achieve a tight installation even if the indicator is not fully green. Always check belt path for no more than 1" movement.*

SECURING THE CHILD

- 1 Loosen and unbuckle harness.
- 2 Place child in Child Restraint making sure their body is making full contact with the seating surface.
- 3 Adjust Active Response Headrest so it is positioned at the child's shoulders to ensure proper fit of the harness. The headrest can lightly touch the shoulders and allow at most 1" of space between child's shoulders and headrest.
- 4 Place harness over child and insert buckle tongues into the buckle until a "click" is heard. Pull up on the buckle tongues to make sure they are locked.
- 5 Pull up on the harness to remove excess slack around the child's legs. Pull harness adjuster strap to tighten.
- 6 Close the retainer clip and position the top of the clip at armpit level.
- 7 Harness should be snug. Pinch harness webbing at child's shoulder (under shoulder pad). If you can pinch webbing, the harness is too loose and should be tightened.

NOTE: Harness pads are optional and can be removed to help get the retainer clip to armpit level.

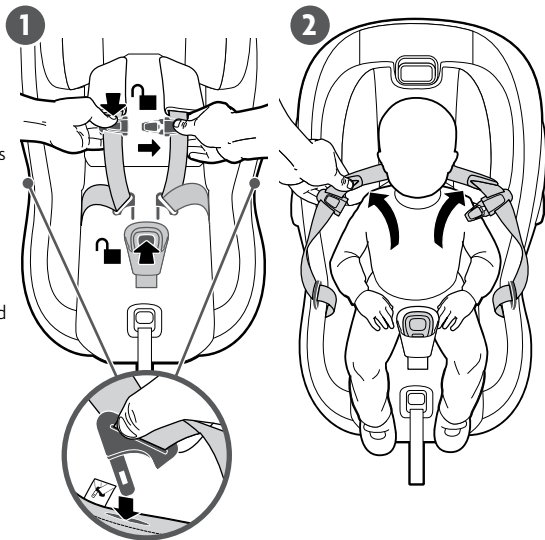

SECURING THE CHILD

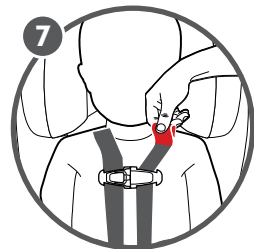
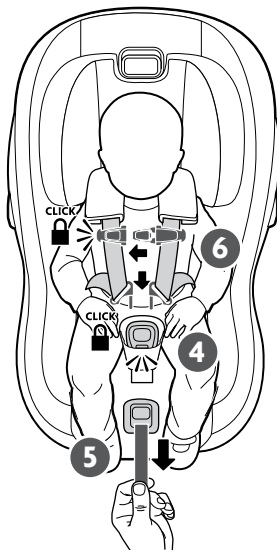
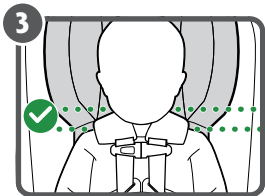

Remove the Fit Inlay at **25 lbs (11.3 kg)** or when the child begins growing on top of the buckle making it difficult to buckle the harness. The Fit Inlay has a two-piece construction. If the child is less than 25 lbs, first remove the Fit Inlay Back Cushion and readdress the harness fit. If still tight around the child's thighs remove the Fit Inlay completely.

FABRIC CARE – Removing Seat Pad

- 1 Raise headrest to highest position.
- 2 Unfasten back panel fabric.
- 3 Remove crotch buckle cover.
- 4 Fully unzip seat base fabric.
- 5 Unsnap seat base fabric.
- 6 Pull fabric out from around Harness Adjuster Housing and remove from seat.

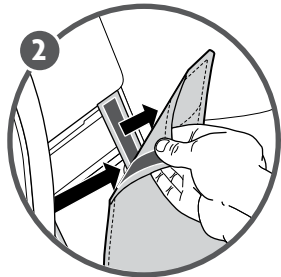
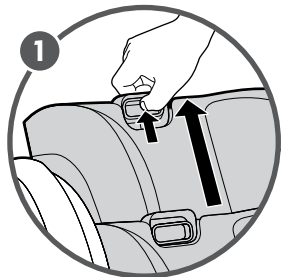

FABRIC CARE – Removing Seat Pad

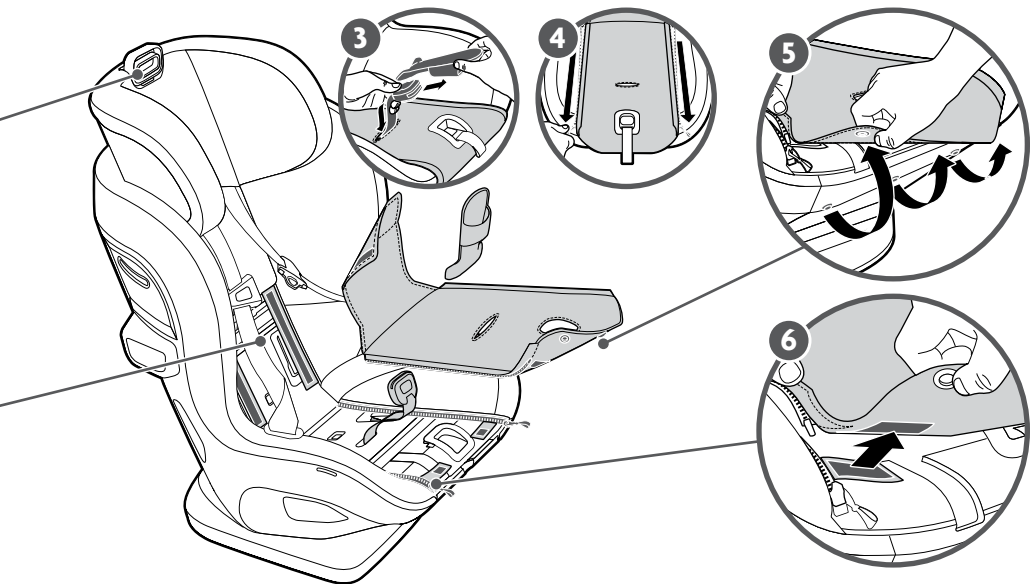

FABRIC CARE – Removing Headrest Fabric

- 1 Raise headrest to highest position.
- 2 Unfasten headrest from seat.
- 3 Unhook elastic from lower portion of headrest.
- 4 Pull headrest fabric from spine structure and remove from seat.

NOTE: *DO NOT* remove foam ears from seat. These cannot be cleaned.

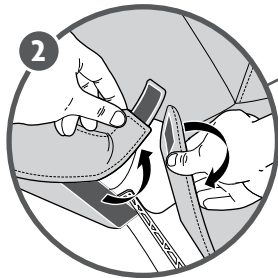
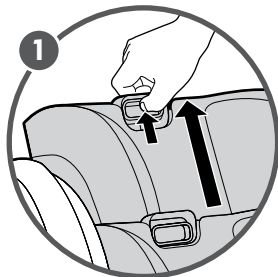

FABRIC CARE – Removing Headrest Fabric

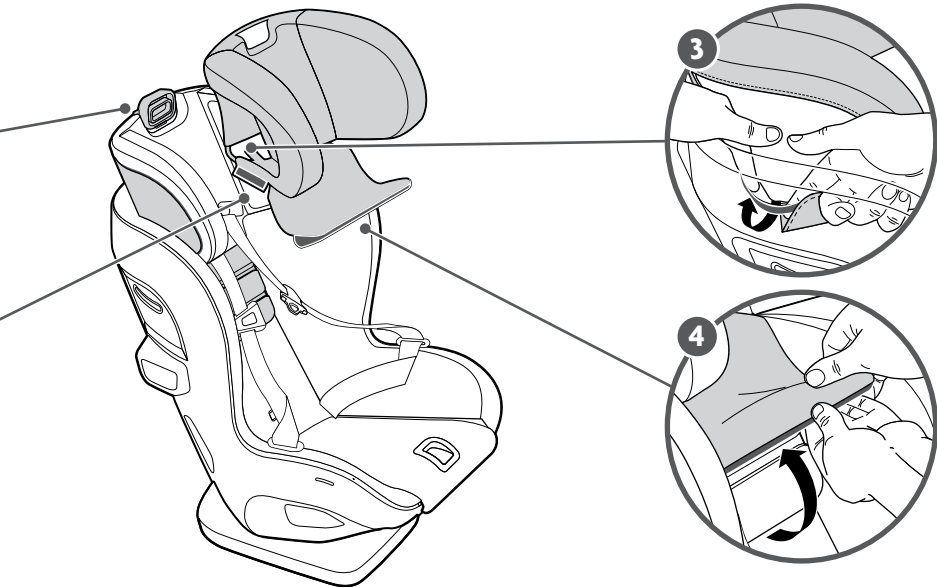

FABRIC CARE – Removing Seat Fabric

- 1 Unclip Tether from back of seat
- 2 Pull plastic tabs around top of seat and pull to remove around plastic Headrest Adjuster Handle and feed tether through hole in top of seat to remove.
- 3 Pull body fabric from channel along side of seat.

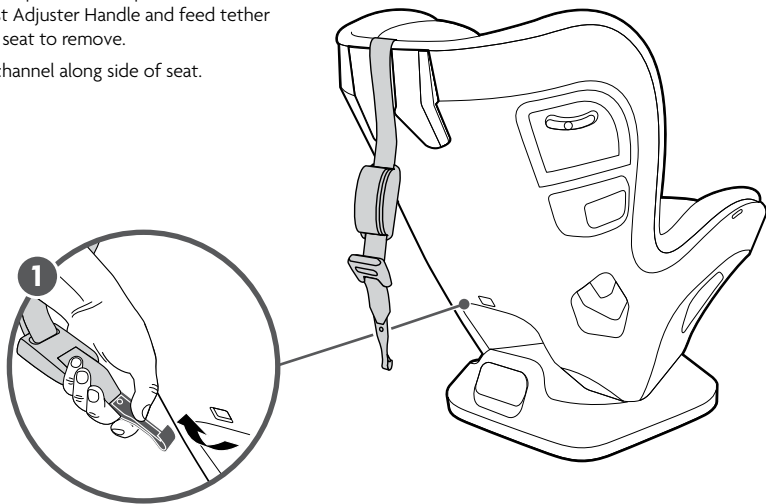

FABRIC CARE – Removing Seat Fabric

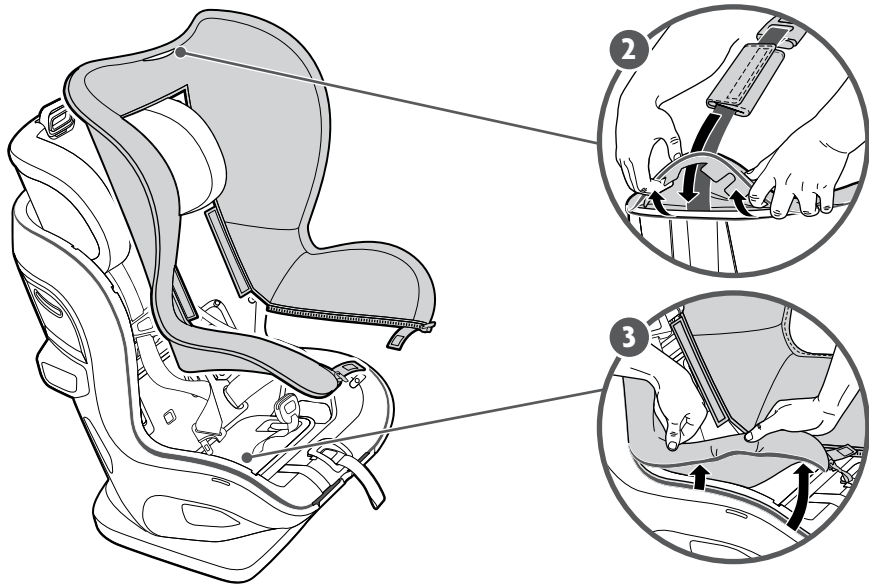

FABRIC CARE – Installing Seat Fabric

- 1 Place seat fabric over seat and feed tether through hole in top of seat fabric. Attach plastic tabs to seat.
- 2 Attach tether to anchor located at back of seat.
- 3 Moving from the top down, press fabric into channel along side of seat.

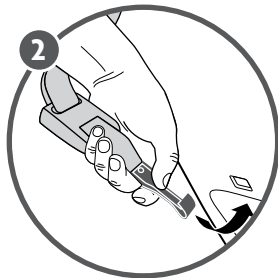
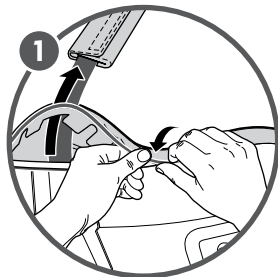

FABRIC CARE – Installing Seat Fabric

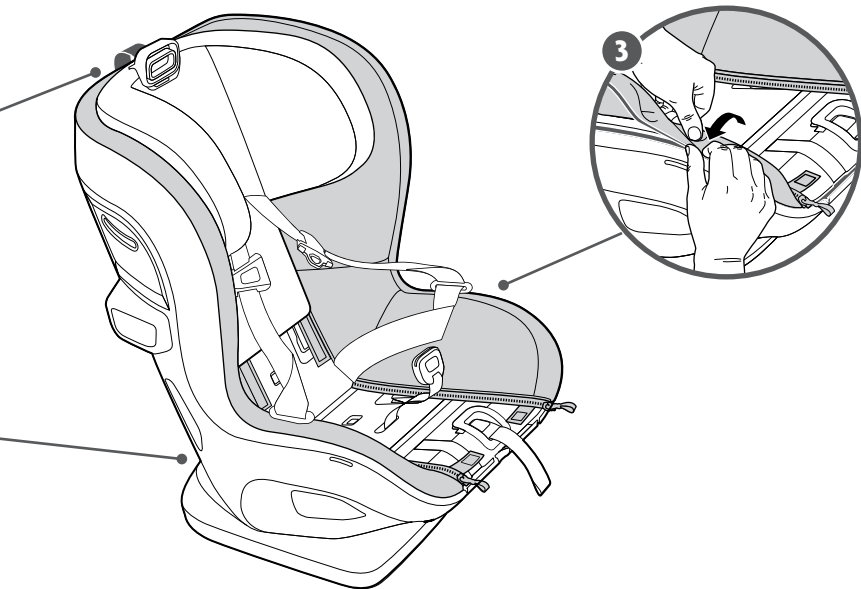

FABRIC CARE – Installing Headrest Fabric

- 1 Tuck harness buckles into holders on side of seat.
- 2 Attach elastic loops to back of headrest.
- 3 Slide headrest fabric between plastic shell.
- 4 Fasten fabric to headrest/seat.
- 5 Pull lower panel of headrest fabric around headrest back panel.

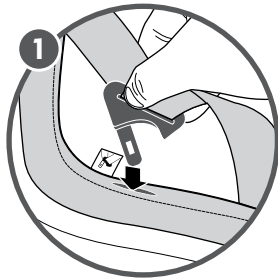
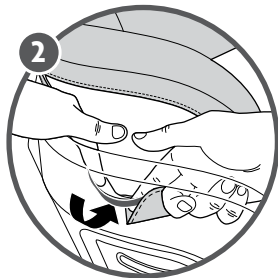

FABRIC CARE – Installing Headrest Fabric

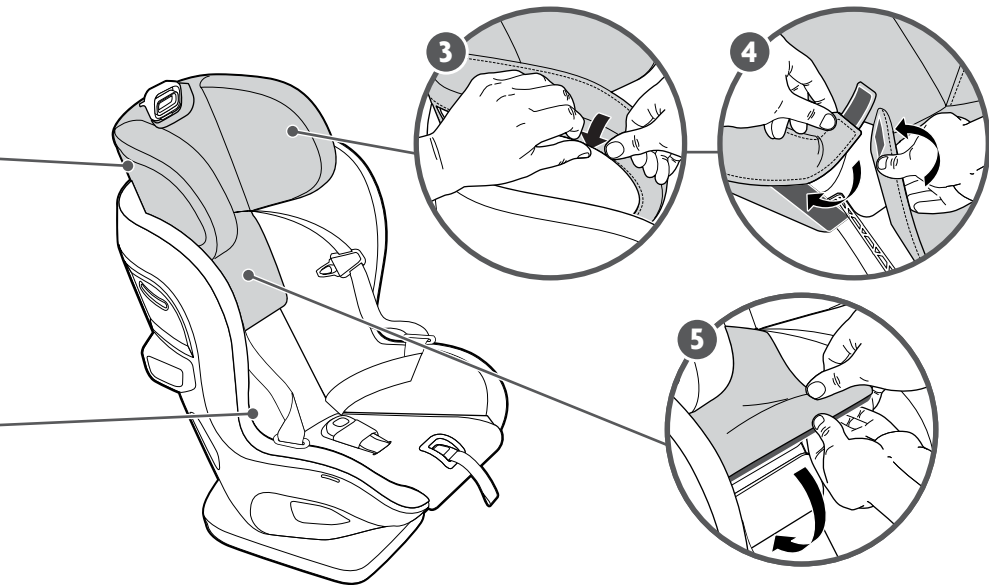

FABRIC CARE – Installing Seat Pad

- 1 Place seat pad cover into seat and wrap fabric around Harness Adjuster Button Housing.
- 2 Replace crotch buckle cover by feeding crotch buckle into sleeve and tucking fabric ears beneath seat fabric. Feed crotch buckle through slot in seat pad.
- 3 Attach zippers on either side of seat base fabric.
- 4 Zip closed.
- 5 Fasten seat base fabric to back of seat.
- 6 Fasten seat base fabric to alongside zipper.
- 7 Snap front panel to seat.

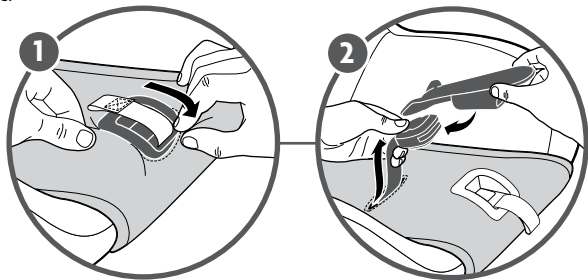

FABRIC CARE – Installing Seat Pad

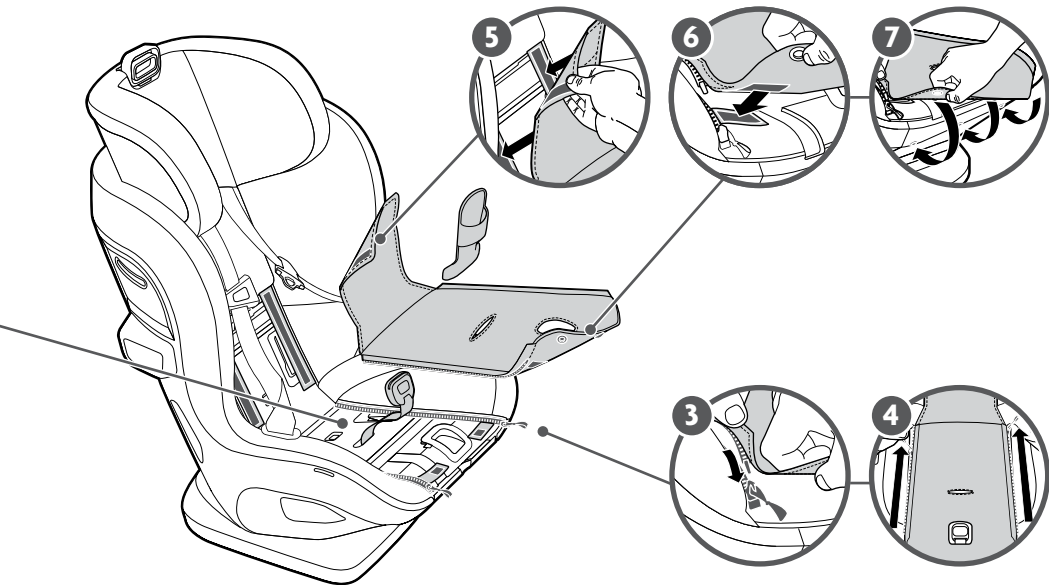

CLEANING AND MAINTENANCE

CLEANING FABRICS — Fabrics include: seat and headrest covers, fit inlay, harness covers and crotch buckle cover



Machine wash in cold water on gentle cycle with mild detergent. **DO NOT** bleach.



Dry flat and away from direct sunlight before re-use or storage.



DO NOT iron or dry clean.

CLEANING HARNESS WEBBING



Spot clean using warm water with mild detergent. **DO NOT** bleach.



Air dry completely before re-use or storage.

CLEANING PLASTIC



Spot clean using warm water with mild detergent.



Towel dry completely before re-use or storage.

CLEANING LOWER ANCHOR CONNECTORS — Anchors should fasten with a “click”. If not, rinse under warm running water. **DO NOT** use detergents or lubricants.

WARRANTY



Welcome to the UPPAbaby family! We are with you for the long haul. Register your car seat within three months to claim your Limited Lifetime Warranty*.

Register your product at: uppababy.com/register

* Lifetime warranty applies to UPPAbaby car seats and only the original owner, within the lifetime of the product. To receive your Limited Lifetime Warranty, you **MUST** register your car seat within three months of purchase and provide a valid purchase receipt from an authorized UPPAbaby retailer. The “lifetime” of the product is defined as the period of use by the registrant for use with his/her children up to 10 years from date of manufacture.

Your UPPAbaby product is warranted to be free from any manufacturing defects for a period of 2 years from the date of purchase under normal use and in compliance with the operating instructions.

This warranty is not transferable and extends only to the original retail purchaser and is only valid when supplied with proof of purchase from an authorized retailer. Proof of purchase must be retained for this warranty.

The warranty is valid only in the original country of purchase. This warranty is subject to the conditions set forth by country in which the items were purchased. Conditions may vary. UPPAbaby will not ship replacement or repair parts out of the country of purchase.

UPPAbaby will provide replacement parts or conduct repairs as determined fitting by the company. UPPAbaby reserves the right to exchange item with a replacement part. Some parts may be replaced with newer model parts as the product is improved over time.

WARRANTY

This warranty does not cover:

- Defects caused by misuse or poor maintenance. (Please refer to the product instruction booklet for guidance on item use and maintenance).
- Damage caused by improper installation of UPPAbaby parts and/or accessories. (Please refer to product instruction booklet for guidance on item assembly and use).
- Damage caused by corrosion, mold or rust due to poor maintenance, service or storage.
- Damage resulting from normal wear and tear.
- Damage or degradation caused by the sun, sweat, detergents, damp storage conditions or frequent washings.
- Repairs or modifications carried out by a third party.
- Product purchased from an unauthorized retailer. (Approved retailers are listed on our website uppababy.com).
- Second owners and users other than the registrant.
- Damage resulting from airline shipping and handling.
- Products Involved in an accident.

UPPAbaby reserves the right to determine if warranty terms and conditions have been met.

For warranty service: In the US and CA please contact UPPAbaby customer service (844) 823-3132 and visit uppababy.com/support to send an email.



USA | UPPAbaby, 276 Weymouth Street, Rockland, MA 02370 | uppababy.com | 1.844.823.3132

Model 1120-KNX-US

All rights reserved. © 2022 UPPAbaby. UPPAbaby and all associated logos are trademarks. All product specifications are correct at time of print. UPPAbaby reserves the right to change anything at any time without prior notice. Color representation is as close as print processes allow. Not all colors available at all retailers. **UbMAN001-V06**