

 UPPAbaby[®]

MINU[®] **V2**

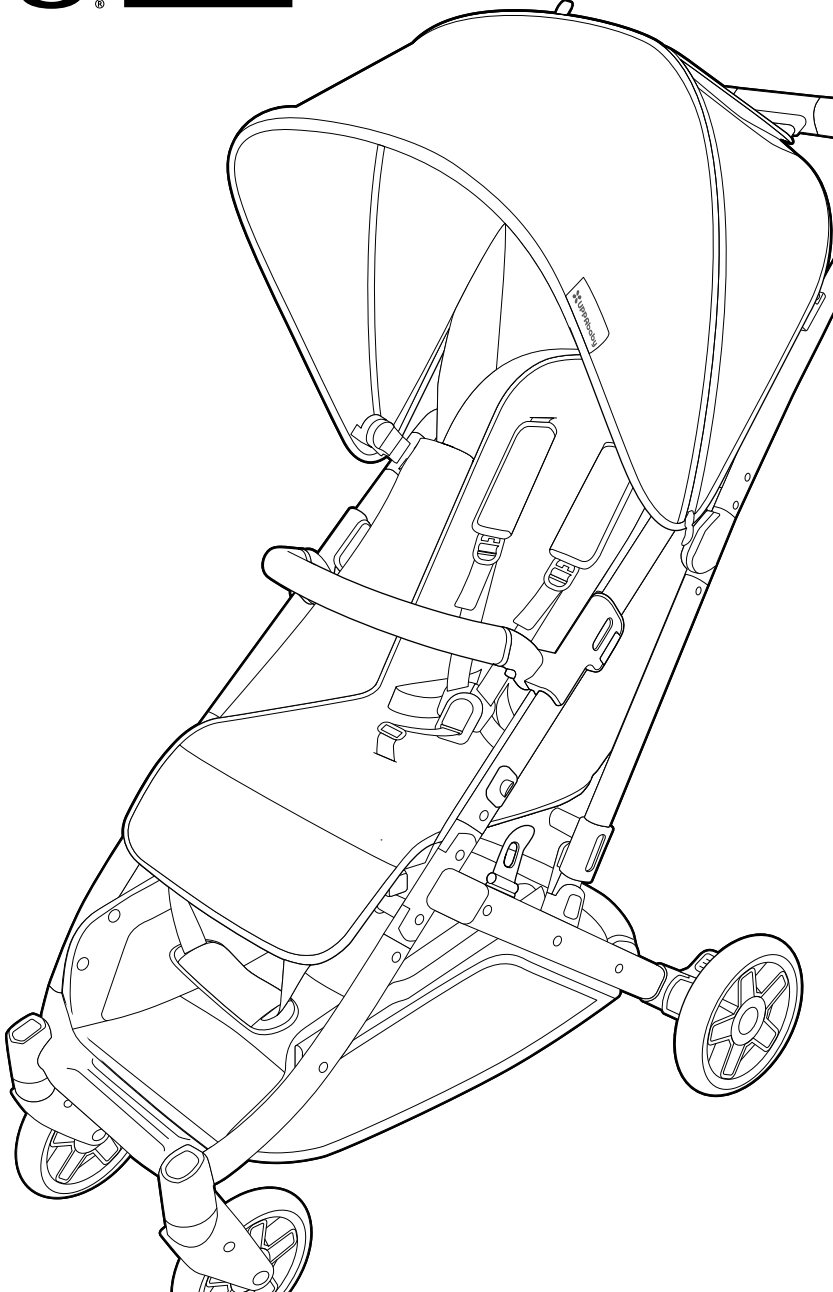

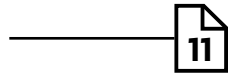

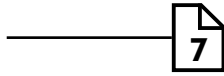
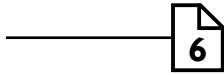
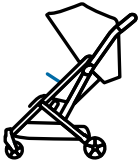
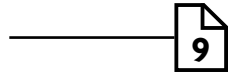
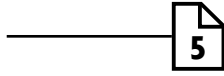
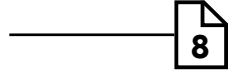
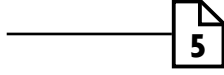
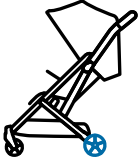
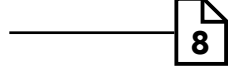
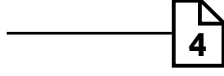
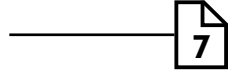
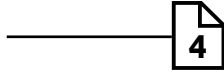
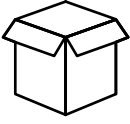
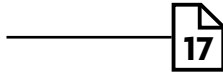
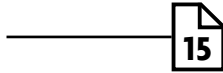
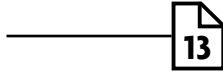
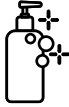
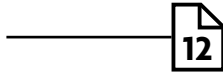
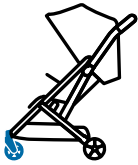

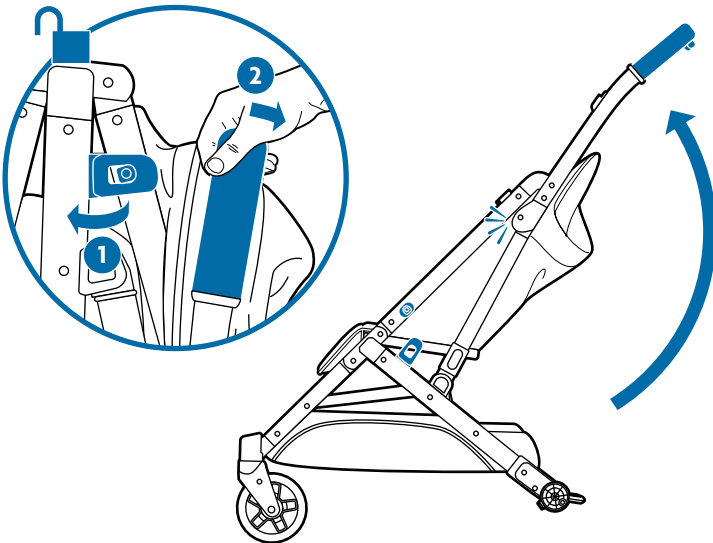
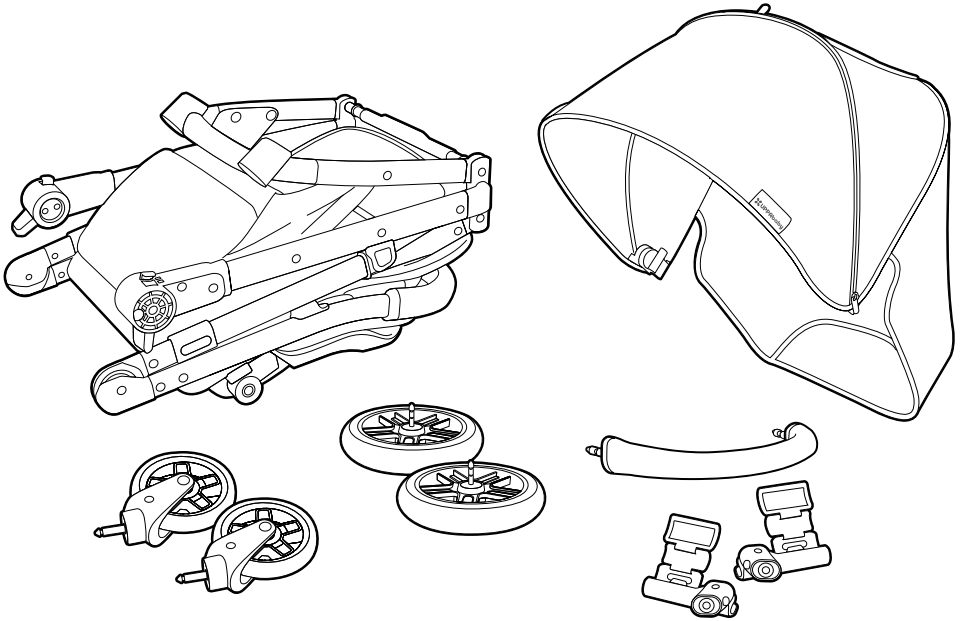
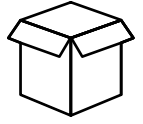

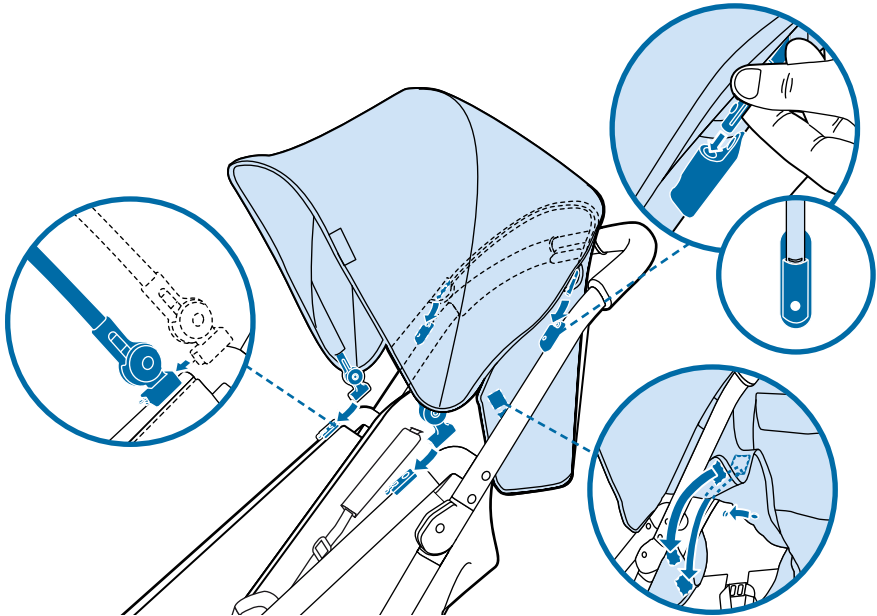
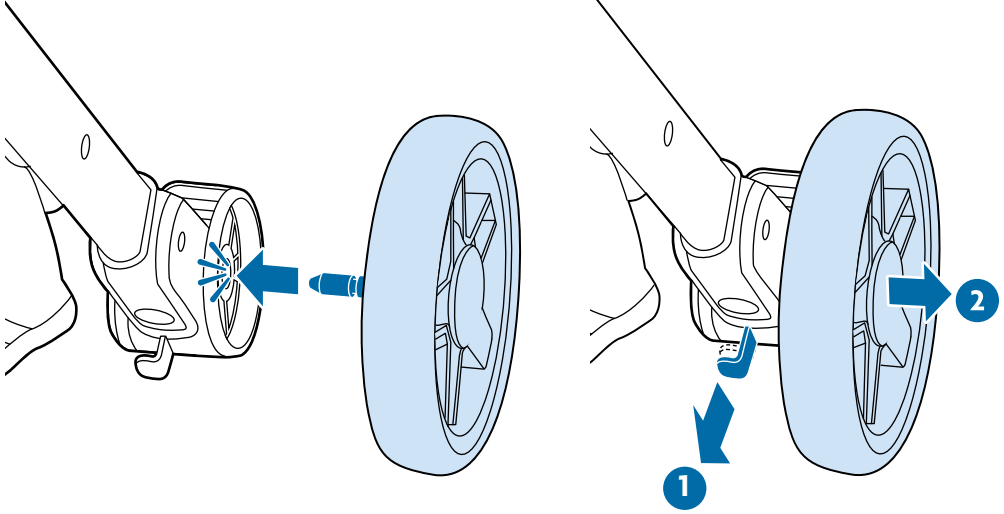
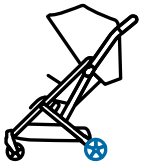

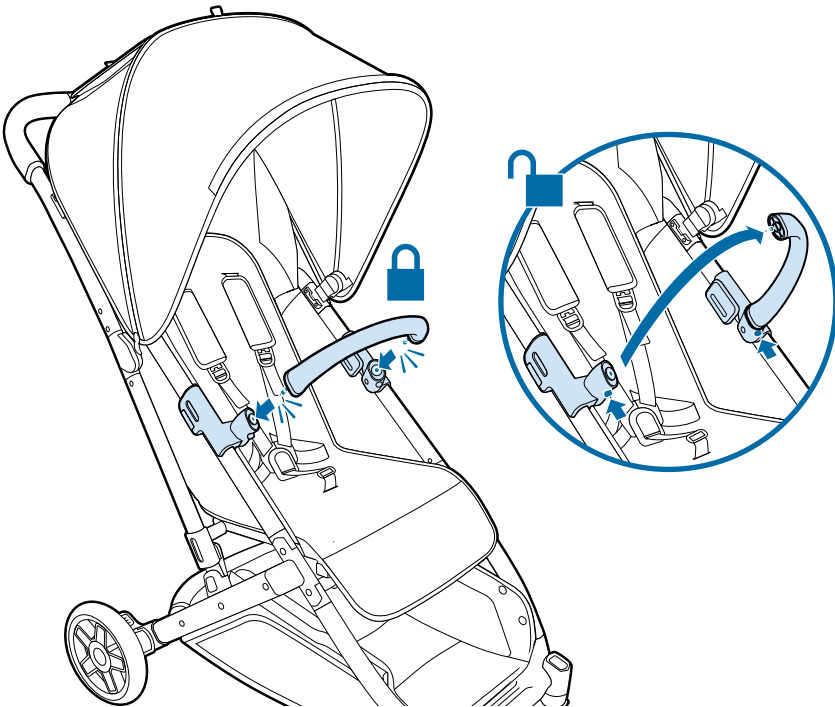
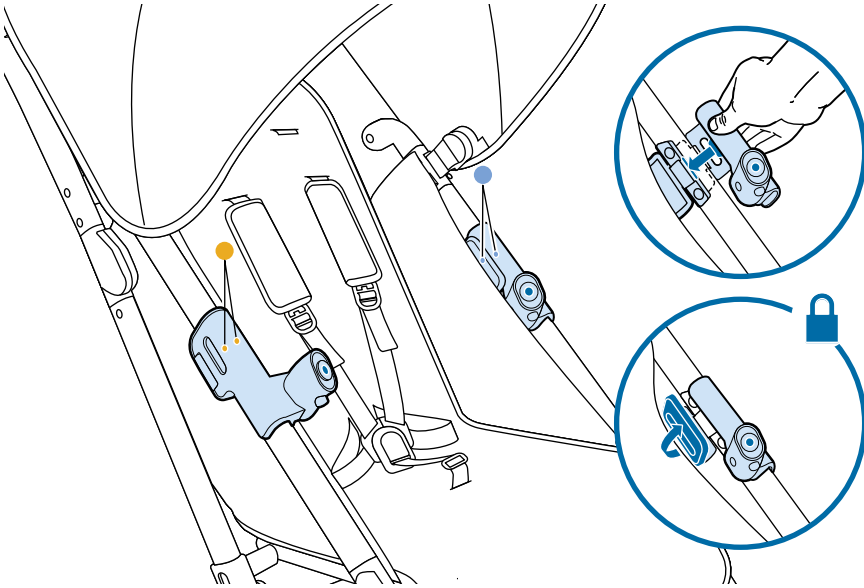

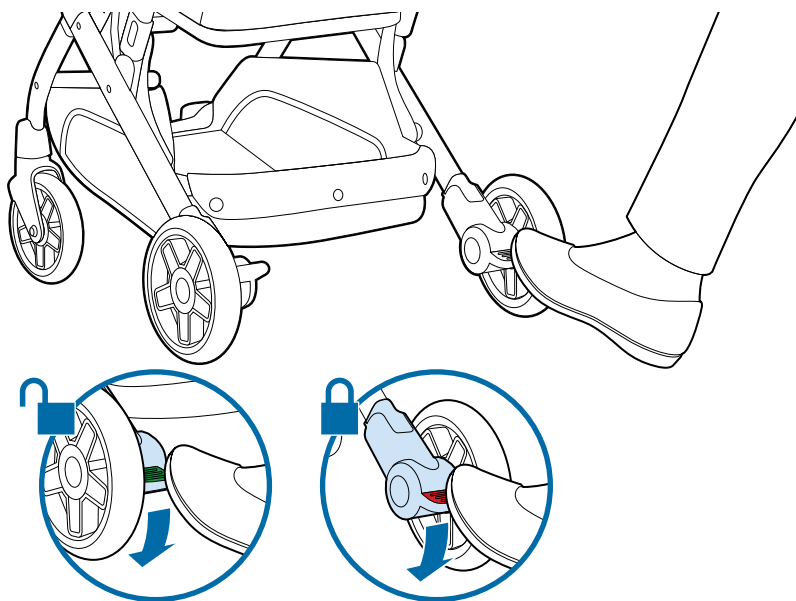
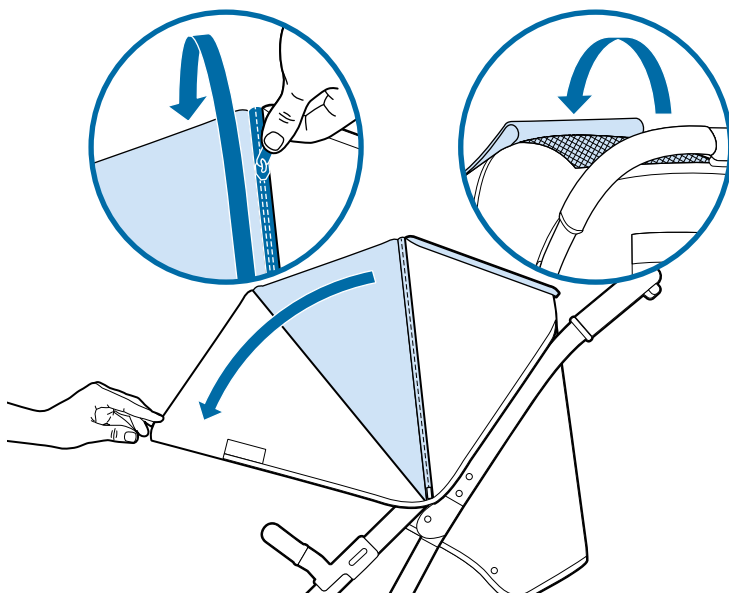

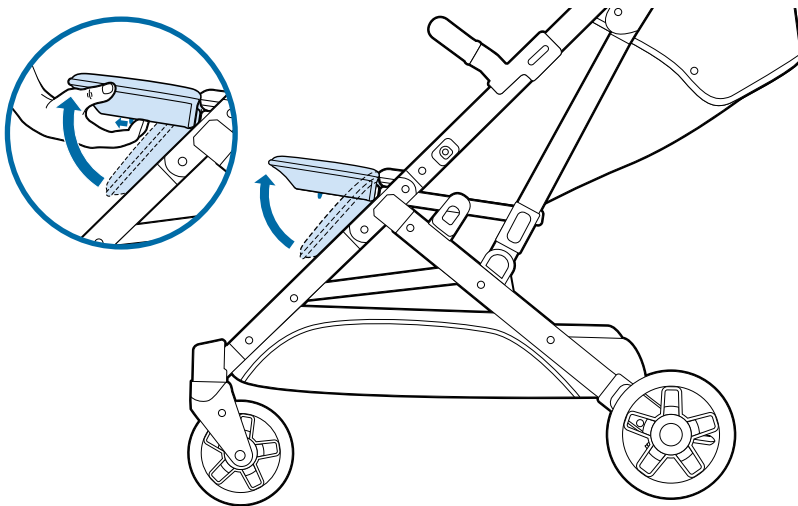
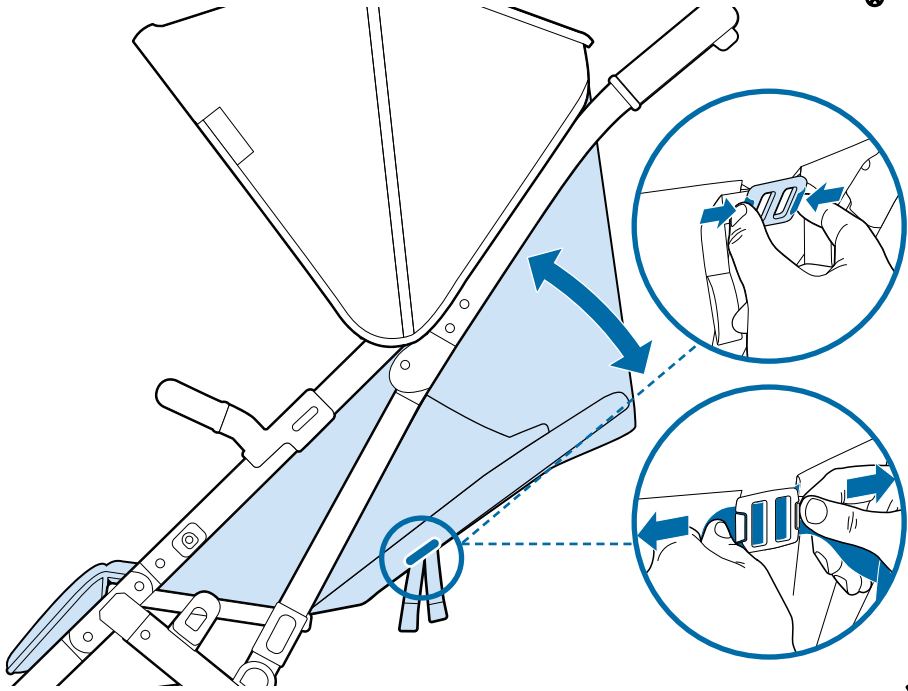

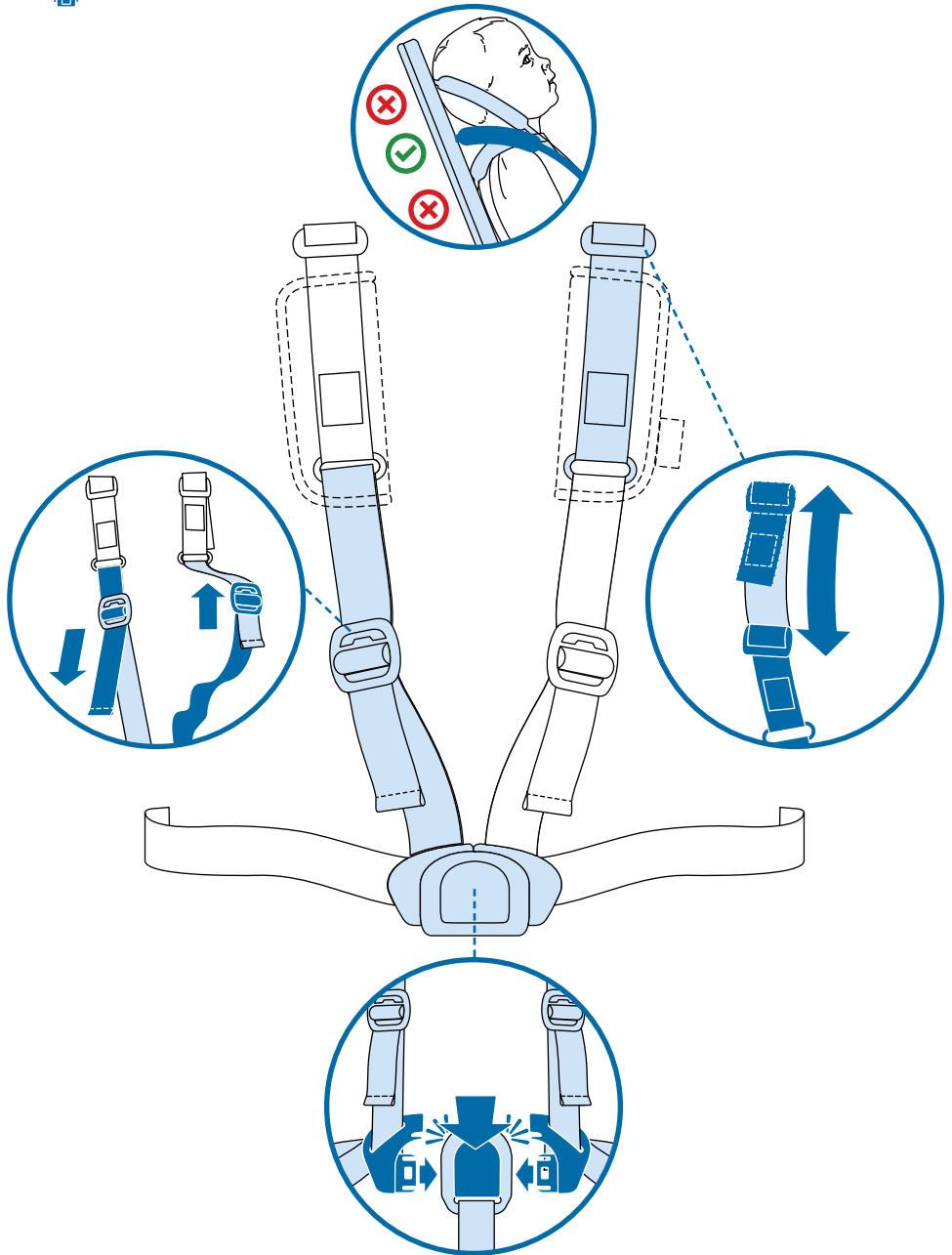

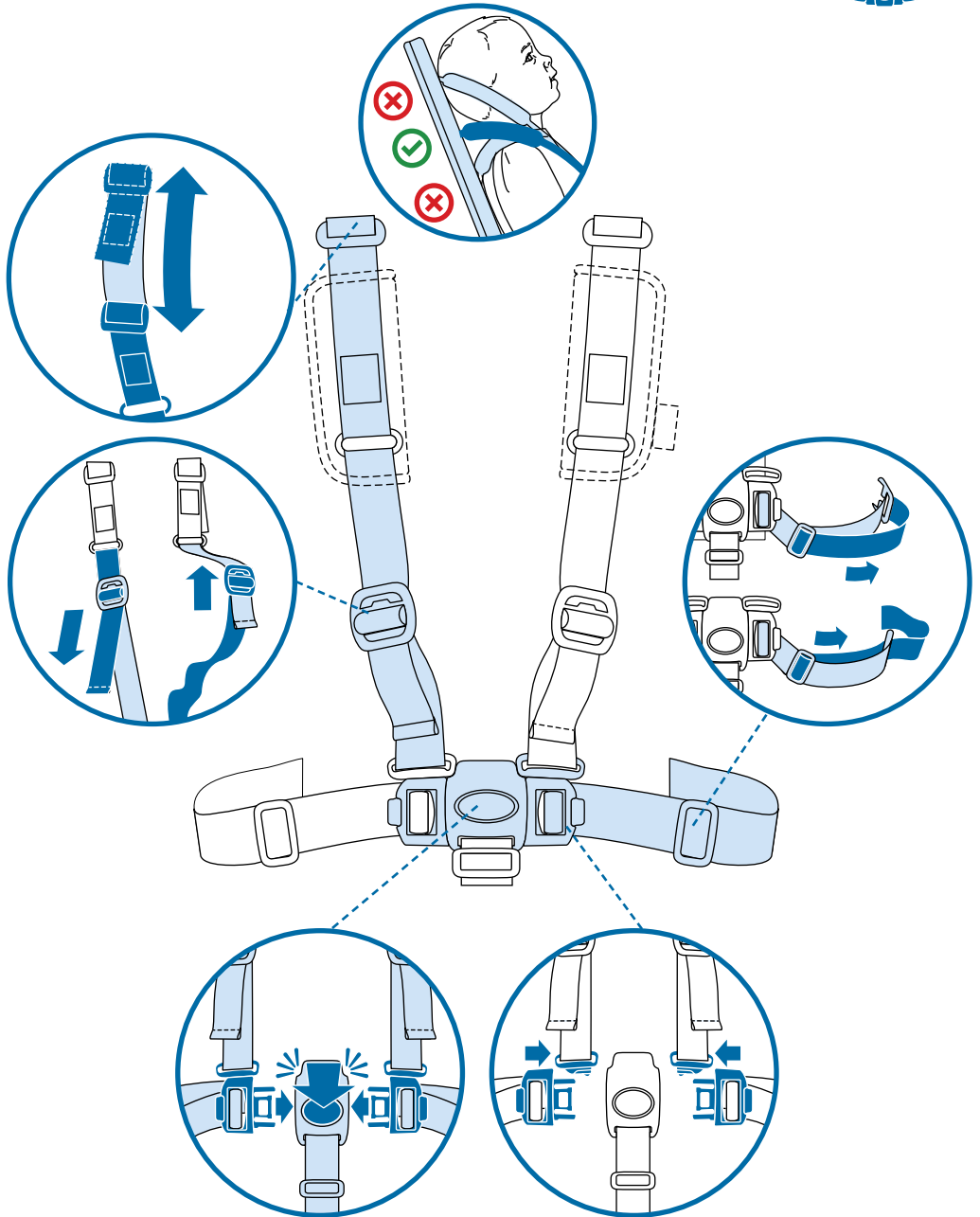

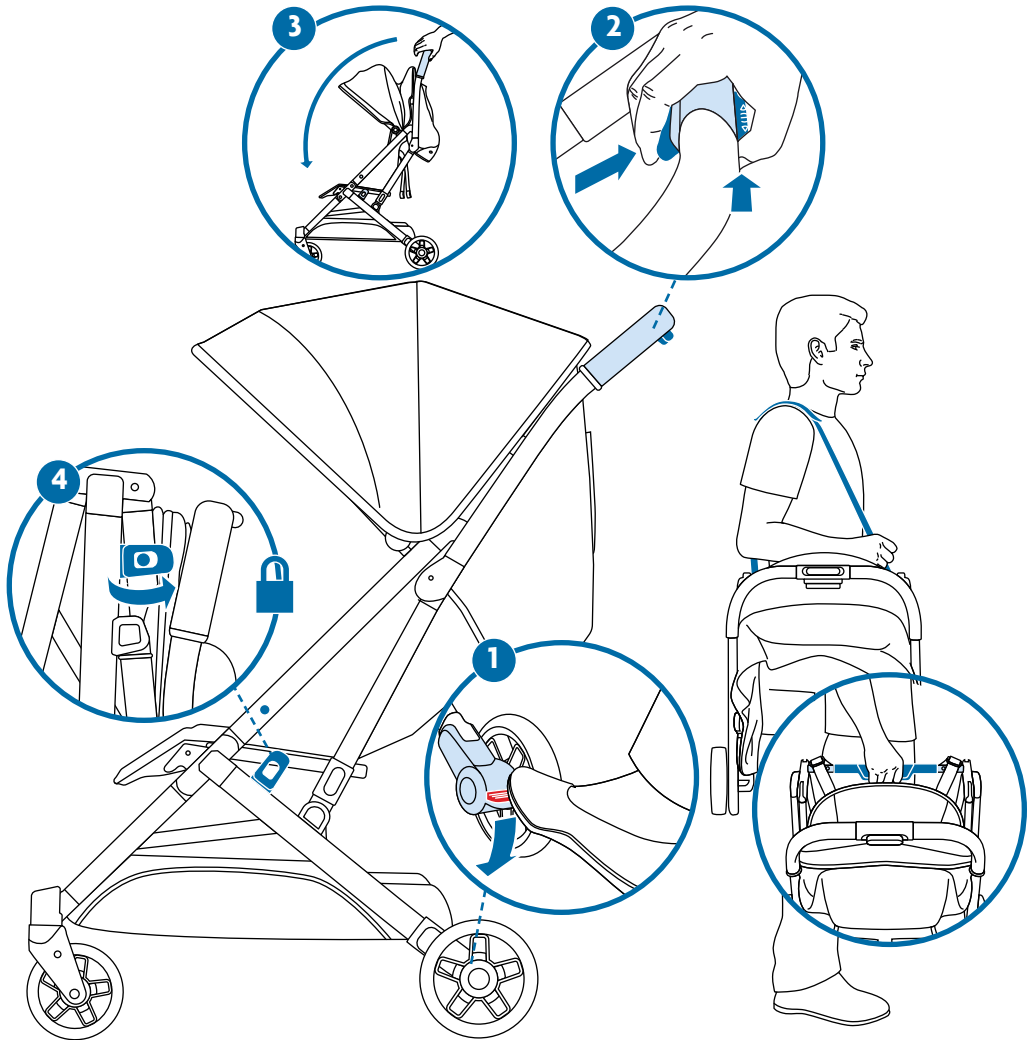

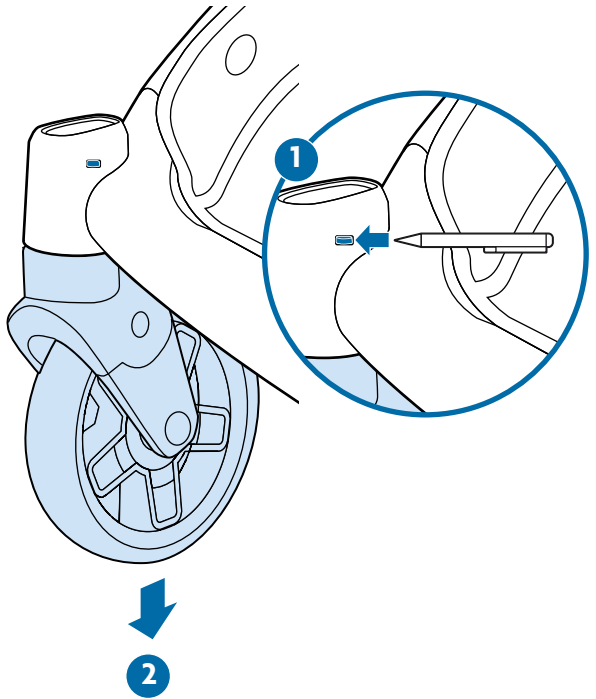
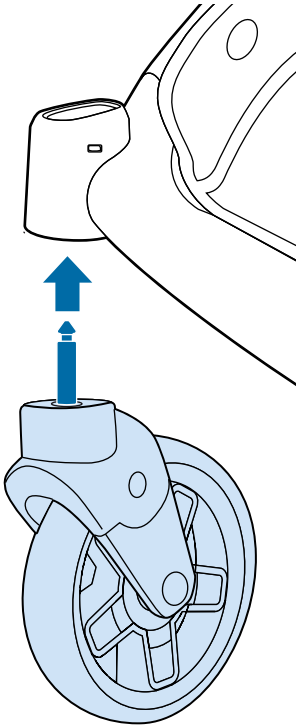
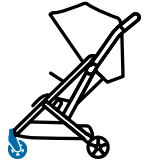

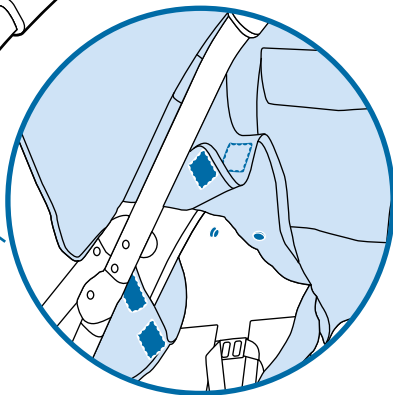
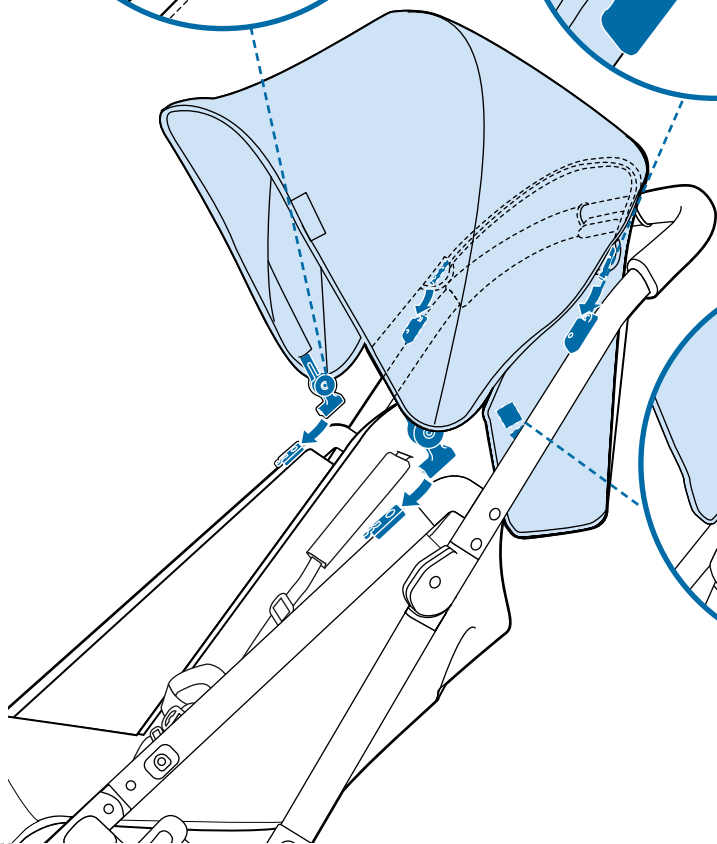
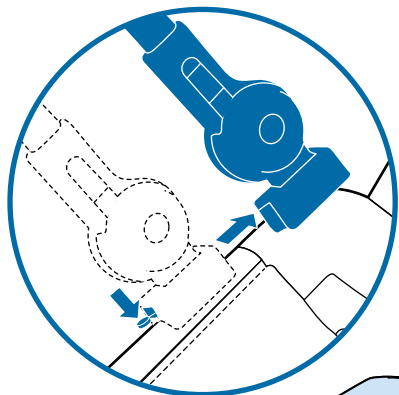

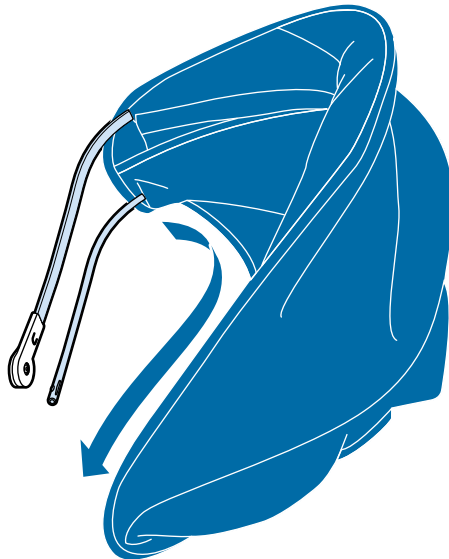
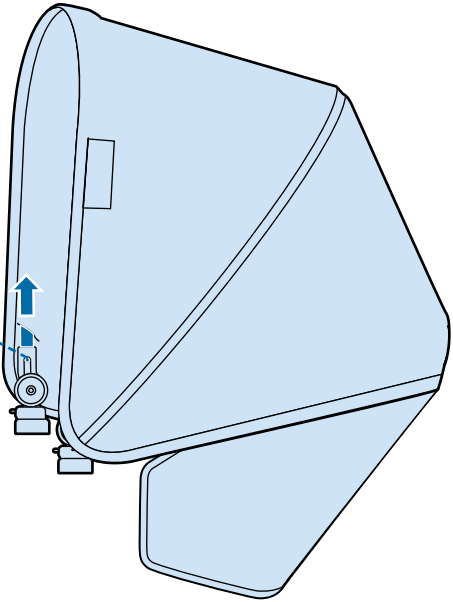
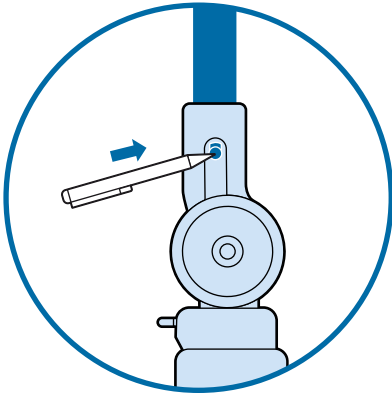
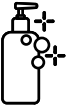

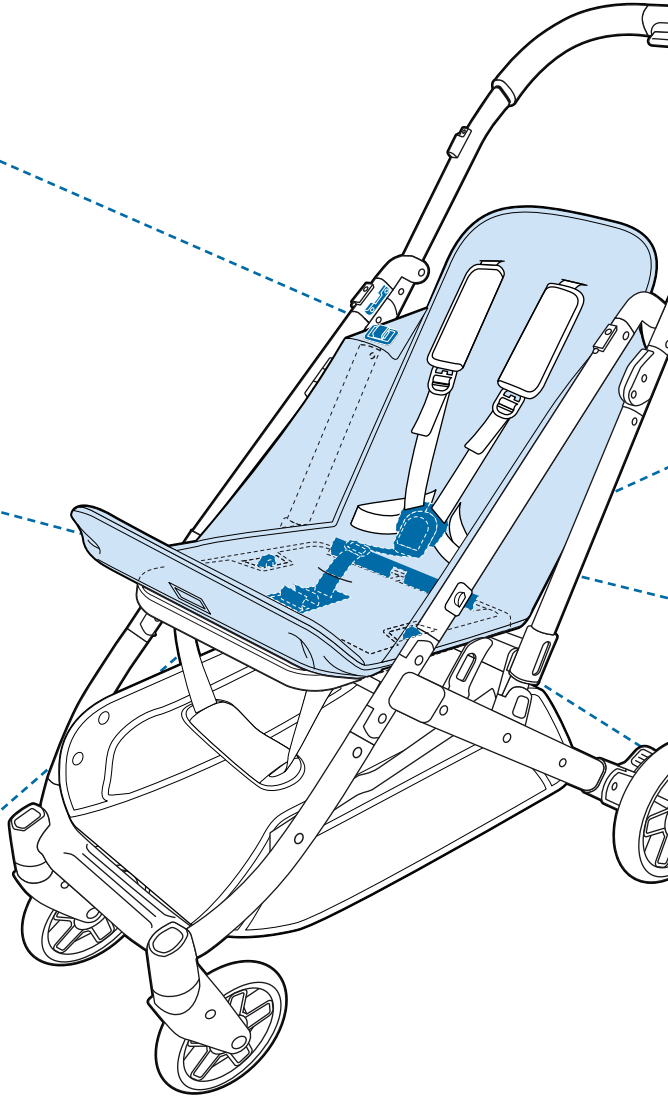
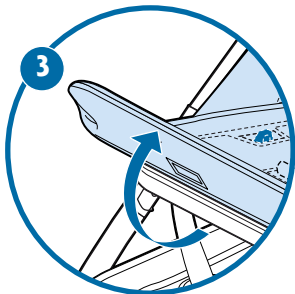
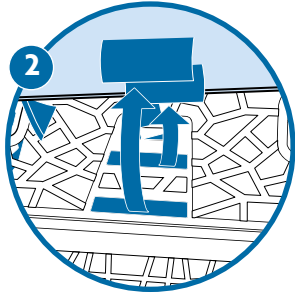
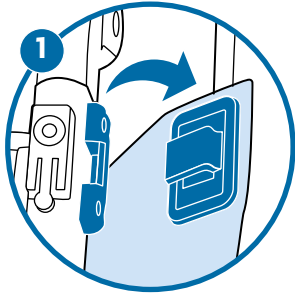
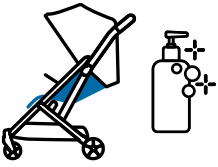

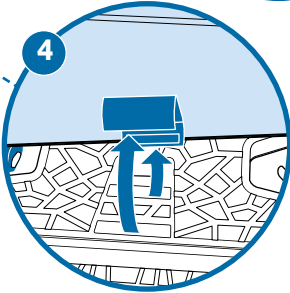
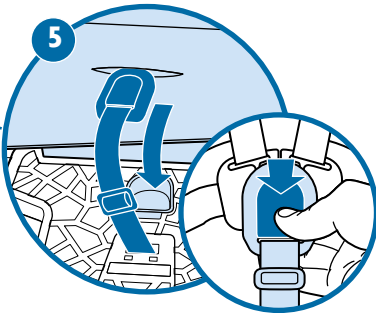
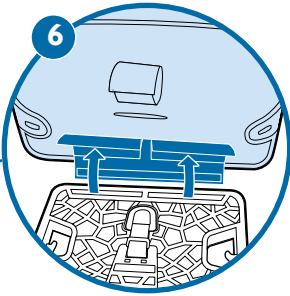
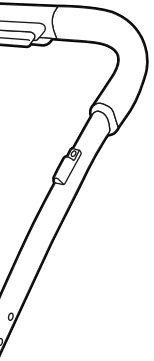
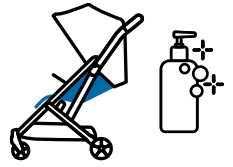

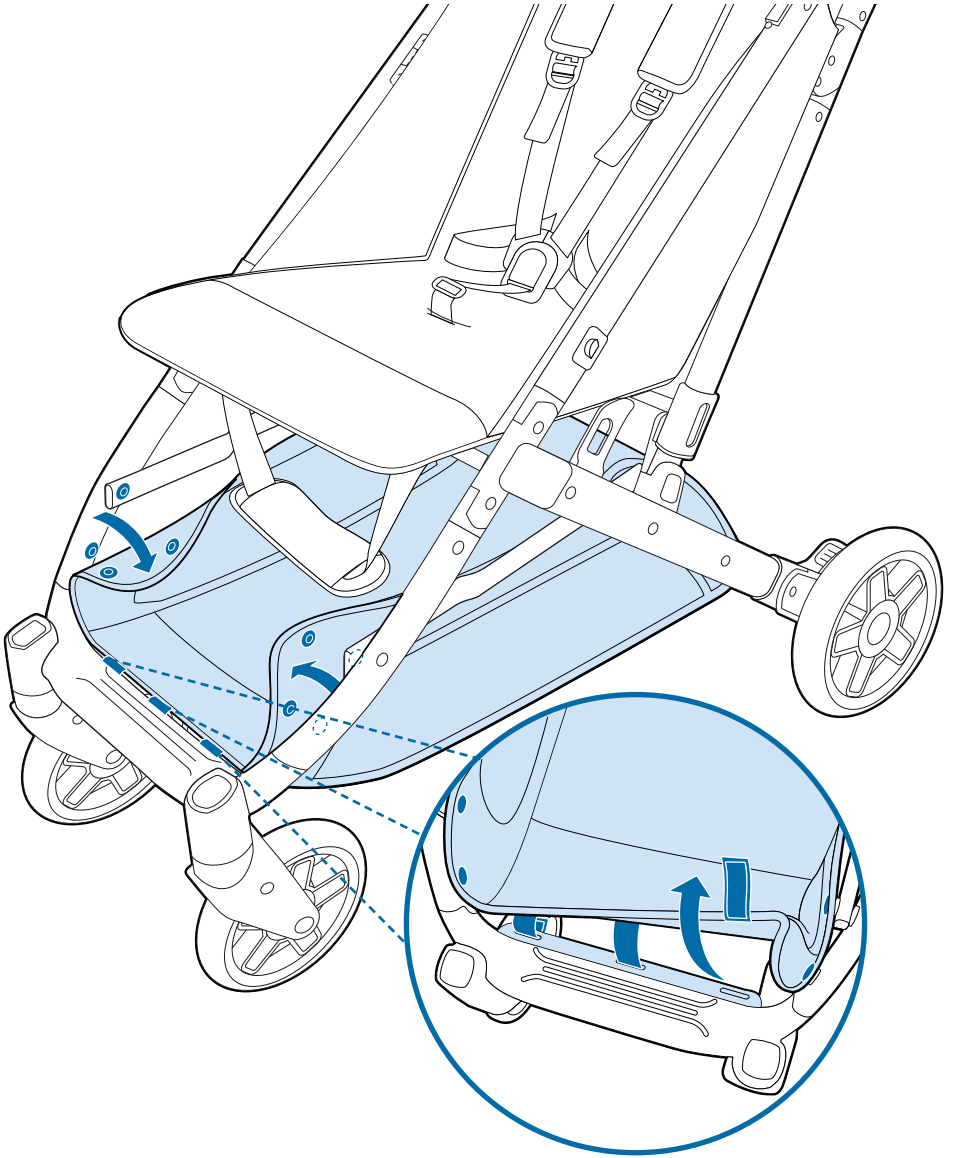
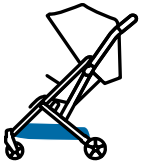

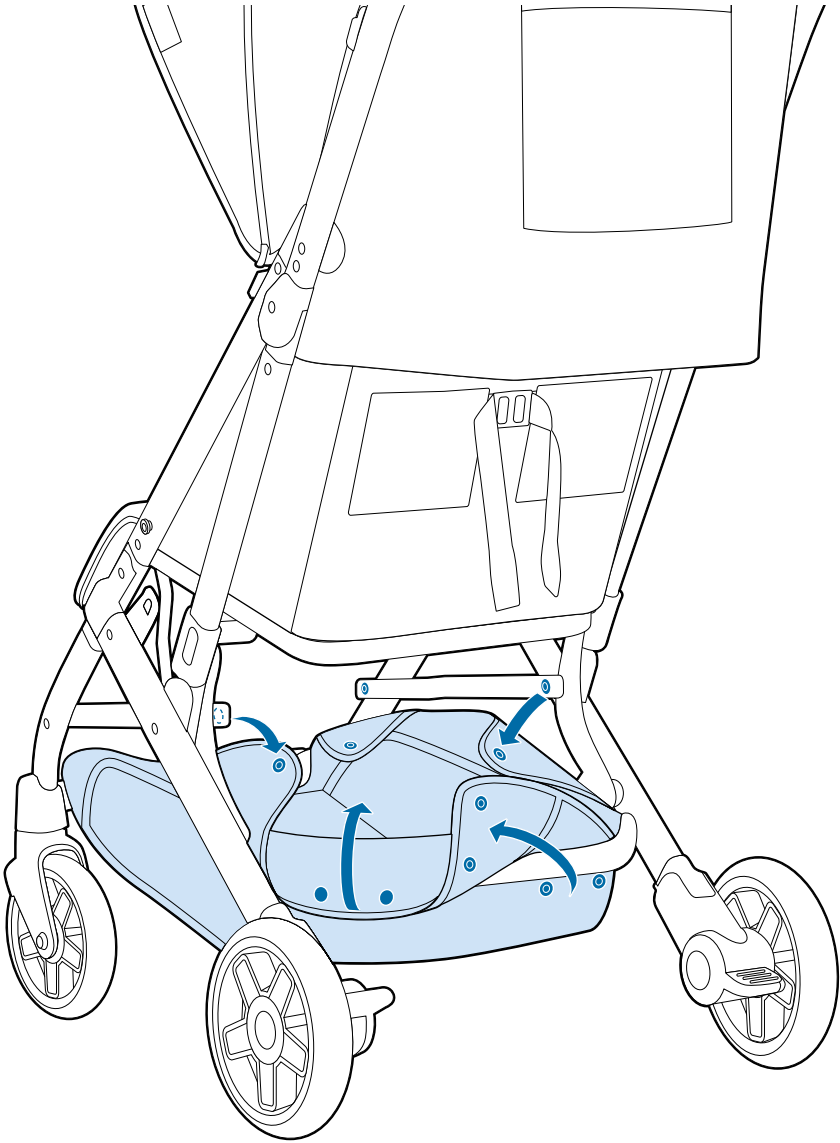
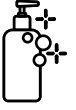
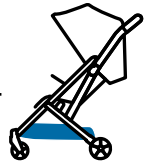



USA | UPPAbaby, 276 Weymouth Street, Rockland, MA 02370
Canada | 5514KM, 201 Wicksteed Avenue, Suite 2, Toronto, Ontario M4G 0B1
uppababy.com | 1.844.823.3132

Model 0802-MIN

All rights reserved. © 2022 UPPAbaby. UPPAbaby and all associated logos are trademarks. All product specifications are correct at time of print. UPPAbaby reserves the right to change anything at any time without prior notice. Color representation is as close as print processes allow. Not all colors available at all retailers. UbMANI08-V02