

UPPAbaby®  
**MESA** V2

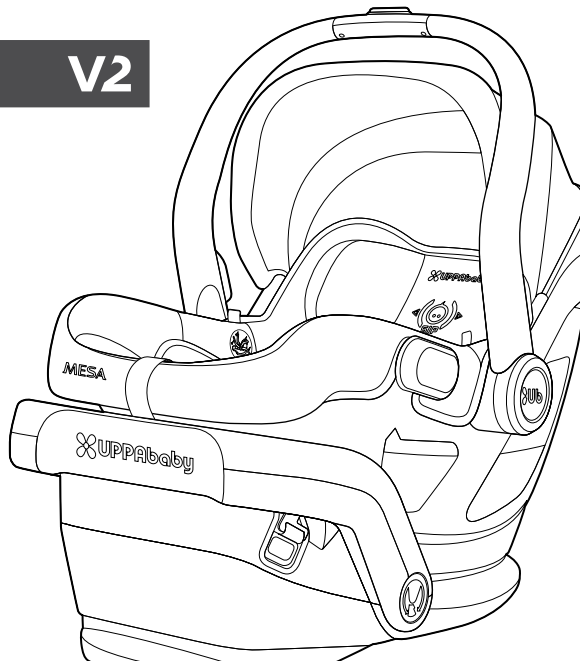

From 4-35 lbs



---

# WELCOME TO THE FAMILY

We are with you for the long haul. Register your car seat within three months to claim your Limited Lifetime Warranty.\*

Thank you for being part of the UPPAbaby family.



\*Lifetime warranty applies to UPPAbaby car seats and the original owner, within the lifetime of the product. To receive your Limited Lifetime Warranty, you MUST register within three months of purchase and provide a valid purchase receipt form an authorized UPPAbaby retailer. The "lifetime" of the product is defined as the period of use by the registrant for use with his/her children up to 7 years from date of manufacture. For complete UPPAbaby Warranty refer to page 69.

For replacement parts, service or additional questions, please contact our Customer Experience Team:  
[uppababy.com/support](http://uppababy.com/support) | email: [support@uppababy.com](mailto:support@uppababy.com) | 844-823-3132

## **Before You Begin**

Registration	
Certification	
Child Use Recommendations	
Notice of Expiration	

## **Warnings + General Safety Instructions**

Features Overview	
Overview of Base	
Overview of Carrier	

## **Vehicle Compatibility**

Choosing A Vehicle Seating Location	18
Determining Best Installation Method	19
LATCH (Lower Anchors and Tethers for Children)	20
Overview of Vehicle Seat Belt Systems	21
Unsafe Vehicle Seat Belt Systems + Seating	22

<b>4</b>	<b>Base Installation With Lower Anchors</b>	<b>24</b>
4	Leveling the Base	24
4	Base Installation With Lower Anchors	25
5	What is a Waterfall?	26
6	Safety Check	28
	Uninstalling the Base	29
<b>7</b>		
<b>14</b>	<b>Base Installation With Vehicle Seat Belt</b>	<b>30</b>
14	Leveling the Base	30
16	Lap/Shoulder Belt Routing Method	32
	Lap Belt Only Belt Routing Method	34
	What is a Waterfall?	36
	Safety Check	38
	Uninstalling the Base	39

<b>Carrier Installation with Vehicle Seat Belt</b>	<b>40</b>	<b>Stroller Compatibility</b>	<b>60</b>
Determining Best Installation Method	40	Fitting Carrier to Stroller Frame	60
Leveling the Carrier	41	Releasing Carrier from Stroller Frame	61
Lap/Shoulder Belt Preferred Routing Method	42		
Lap/Shoulder Belt Optional Routing Method	44	<b>Care + Maintenance</b>	<b>62</b>
Lap Belt Only Routing Method	46	Cleaning	62
Installation with Locking Clip	47	SIP Padding Removal	63
Safety Check	48	Seat Padding Removal	64
Aircraft Installation	49	Seat Padding Installation	66
		SIP Padding Installation	68
<b>General Use</b>	<b>50</b>	<b>Warranty</b>	<b>69</b>
SIP Carriage + Harness Positioning	50		
Securing Your Child	51		
Crotch Belt Positions	53		
Infant Insert	54		
Attaching Carrier to Base	55		
Releasing Carrier from Base	56		
Using Canopy	57		
Using Carry Handle	58		
Important Checks	59		

**Read all instructions before use  
of this Child Restraint.**

**Keep these instructions for future reference.**  
(Storage pocket located on underside of base.)

## BEFORE YOU BEGIN

### REGISTRATION

Model Number: \_\_\_\_\_

Manufactured Date: \_\_\_\_\_

Expiration Date: \_\_\_\_\_

#### TAKE A MOMENT TO FILL OUT THE ABOVE INFORMATION.

Information can be found on the manufacture labels or engraved on the underside of the carrier.



Child restraints could be recalled for safety reasons. You must register this restraint to be reached in a recall. Send your name, address, email address if available and the restraint's model number and manufacturing date to 276 Weymouth Street, Rockland, MA 02370 or call (844)

823-3132 or register online at: [uppababy.com/register/carseat](http://uppababy.com/register/carseat). For recall information, call the U.S. Government's Vehicle Safety Hotline at 1-888-327-4236 (TTY: 1-800-424-9153), or go to [www.NHTSA.gov](http://www.NHTSA.gov)

### CERTIFICATION



This Child Restraint system conforms to all applicable Federal Motor Vehicle Safety Standards (FMVSS).



This Child Restraint is certified for aircraft use. UPPAbaby and the Federal Aviation Administration (FAA) strongly urge you to secure your child in a Child Restraint system (CRS) or device for the duration of your flight.

This product is designed and manufactured to comply with ASTM 2050 Standard Consumer Safety Specification for Hand Held Carriers.

## BEFORE YOU BEGIN

### CHILD USE RECOMMENDATIONS

Children should remain rear-facing for as long as possible.

UPPAbaby advises that all infants and toddlers should ride in a rear-facing car safety seat (CSS) as long as possible, until they reach the highest weight or height allowed by their CSS's manufacturer. This child restraint is for use by children who meet BOTH requirements below:

WEIGHT REQUIREMENTS: **4–35 lbs (1.8–15.9 kg)**

HEIGHT REQUIREMENTS: **32" (81.3 cm) or less**

The Infant Insert is designed for children who weigh: **4–11 lbs (1.8–5 kg)**

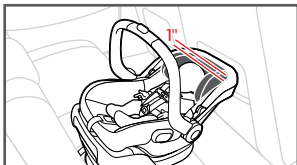

The top of the child's head should not be less than 1" from the top of the headrest when in its highest position.

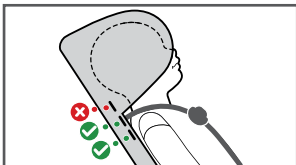

Harness should be at the shoulders or slightly below.

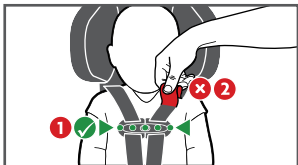

Retainer clip must be at armpit level **1** and harness straps should be snug **2**.

## BEFORE YOU BEGIN

### NOTICE OF EXPIRATION

Discontinue use of this child restraint after 7 years from the date of manufacture or after a crash. Refer to labels on bottom of Carrier and Base.

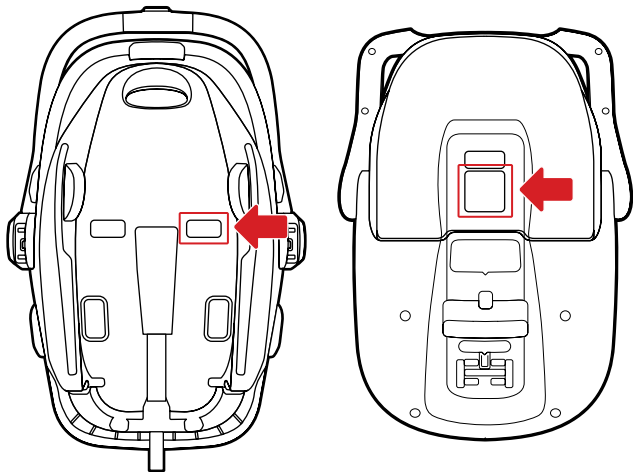



## WARNINGS + GENERAL SAFETY INFORMATION

# **WARNING**

### **DEATH OR SERIOUS INJURY CAN OCCUR**

According to accident statistics, children are safer when properly restrained in the rear seating positions than in the front seating positions. **NEVER** leave Child Restraint unsecured in your vehicle even when it is unoccupied. In a crash, it could become a projectile and injure other vehicle occupants. Use only in rear-facing position when using it in the vehicle.



**NEVER** place this Child Restraint on a front seat with an airbag. **DEATH OR SERIOUS INJURY** can occur. An airbag can strike a rear-facing infant restraint with enough force to crack the shell and seriously injure or kill an infant.

The back seat is the safest place for children 12 and under. Refer to the vehicle owner's instruction book before installing this Child Restraint in a seating position with side airbags.

## WARNINGS + GENERAL SAFETY INFORMATION

Snugly adjust the belts provided with this child restraint around your child. A snug strap should not allow any slack. It lies in a relatively straight line without sagging. It does not press on the child's flesh or push the child's body into an unnatural position.

**SUFFOCATION HAZARD:** Infant carrier can roll over on soft surfaces and suffocate child. **NEVER** place carrier on beds, sofas, or other soft surfaces.

### **WARNING**

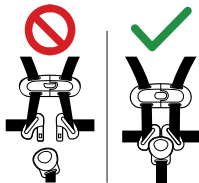

Children have **STRANGLERD** in loose or partially buckled harness straps. Fully restrain the child even when carrier is used outside the vehicle.

## WARNINGS + GENERAL SAFETY INFORMATION

- **NEVER** leave child in carrier when straps are loose or undone.
  - **NEVER** place carrier near window where cords from blinds or drapes can strangle a child.
  - **NEVER** hang strings on or over the carrier or attach to handle.
  - **NEVER** place items with a string around a child's neck, such as hood strings, pacifier cords, etc.
- FALL HAZARD:** Child's movement can slide carrier.
- **NEVER** place carrier on counter tops, tables, or any other elevated surfaces. **DO NOT** use on shopping carts.

## WARNINGS + GENERAL SAFETY INFORMATION

### **WARNING**



**FALL HAZARD:** The carrier can fall from the shopping cart.  
**DO NOT** use on shopping cart.

### **SAFETY WARNINGS**

Failure to follow these instructions could result in serious injury to your child or other vehicle occupants.

- **NEVER** leave child unattended.
- **ALWAYS** keep child properly harnessed when child is in carrier.
- **NEVER** leave child in Child Restraint when straps are loose or undone.

## WARNINGS + GENERAL SAFETY INFORMATION

- **DO NOT** remove or cover up any of the warning or product labels on this Child Restraint. All labels include information required by law.
- **DO NOT** lubricate buckles and fasteners.
- **ALWAYS** check all surfaces of restraint before securing your child. In warm weather, Child Restraints can become very hot. Park in the shade or where sun does not directly hit the Child Restraint. Cover the Child Restraint with a sheet or blanket when not in use.
- **ALWAYS** properly store lower anchor connectors when not in use.
- Check the vehicle owner's manual for more information about airbag/child restraint use.
- **DO NOT** use seat if damaged or broken, expired (over 7 years from date of manufacture), missing instructions, missing parts, or if the straps are cut, frayed, or damaged in any way.

## WARNINGS + GENERAL SAFETY INFORMATION

- **DO NOT** use this Child Restraint system if it has been in a vehicle accident.
- **DO NOT** use clothing or blankets that interfere with fastening or tightening the harness **INSTEAD** place a blanket over the child after being properly secured in the harness.
- **DO NOT** use this Child Restraint system if the top of the child's head is less than 1" from the top of the headrest when in its highest position.
- **DO NOT** use this Child Restraint system in a vehicle seating position where it cannot be tightly secured.
- **DO NOT** install in rear-facing or side-facing vehicle seats.
- **DO NOT** modify this restraint except as instructed in this instruction book. Minor modifications can change the way a Child Restraint performs in a crash.

## WARNINGS + GENERAL SAFETY INFORMATION

- **DO NOT** leave loose objects, e.g. cups, toys, bags, umbrellas, etc., in the vehicle because they can become deadly projectiles in a crash.
- **DO NOT** take child out of the Child Restraint while the vehicle is moving.
- **DO NOT** allow children to play with this Child Restraint. It is not a toy.
- **DO NOT** use any accessories, pads, or products supplied by other manufacturers with this Child Restraint, unless approved and tested by UPPAbaby. Items not tested with this restraint could injure your child.
- **DO NOT** use a Child Restraint with damaged or missing parts.
- **DO NOT** place carrier on top of shopping cart. Carrier will not be secure and could fall causing injury to child.
- **DO NOT** hang objects from Rear Vehicle Seat Belt Guide.

## FEATURES OVERVIEW – Overview of Base

- 1 Vehicle Belt Guides (2)
- 2 Lower Anchor Connector Release Buttons (2)
- 3 Level Adjust Button
- 4 Tightness Indicator
- 5 Lower Anchor Connectors
- 6 Lower Anchor Connector Webbing
- 7 Vehicle Belt Lock-Off (Closed)

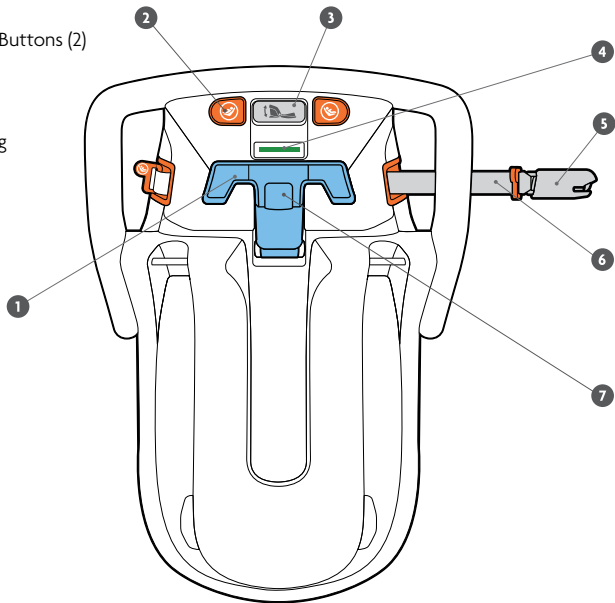



## FEATURES OVERVIEW – Overview of Base

- 8** Vehicle Belt Lock-Off (Open)
- 9** Level Angle Indicators (2)
- 10** Adjustment Foot
- 11** Lower Anchor Connector Storage
- 12** Instruction Manual Storage
- 13** Locking Clip

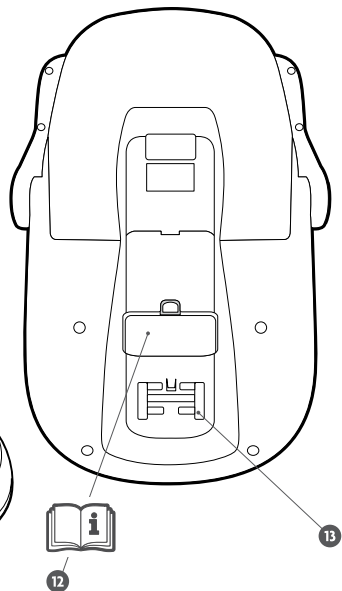
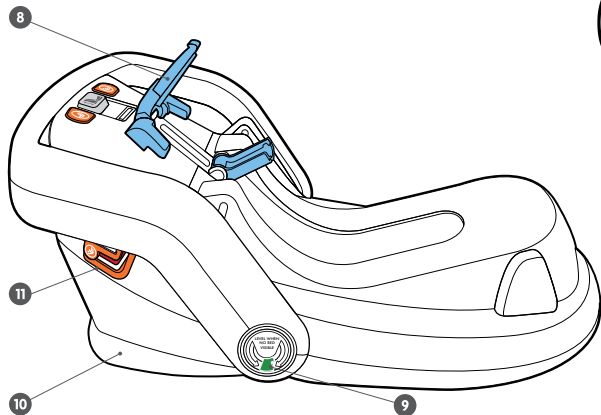

## FEATURES OVERVIEW – Overview of Carrier

- 1 (SIP) Adjuster Tab
- 2 Side Impact Protection (SIP)
- 3 Harness Covers (2)
- 4 Buckle
- 5 Infant Insert
- 6 Harness Adjuster Release
- 7 Harness Adjuster Strap
- 8 Buckle Latch Plates (2)
- 9 Harness Holder Pockets (2)
- 10 Retainer Clip
- 11 Harness Straps
- 12 Canopy
- 13 Manufactured/Expiration Date
- 14 Harness Anchors (2)
- 15 Vehicle Seat Belt Guides (2)
- 16 Carrier Release From Base
- 17 Carrier Release From Stroller
- 18 Carry Handle Adjustment Buttons (2)
- 19 Stroller Attachment
- 20 Rear Vehicle Seat Belt Guide
- 21 Crotch Belt Positions

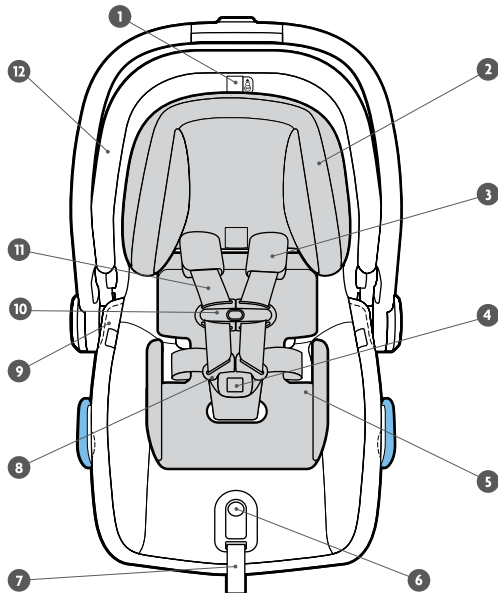

## FEATURES OVERVIEW – Overview of Carrier

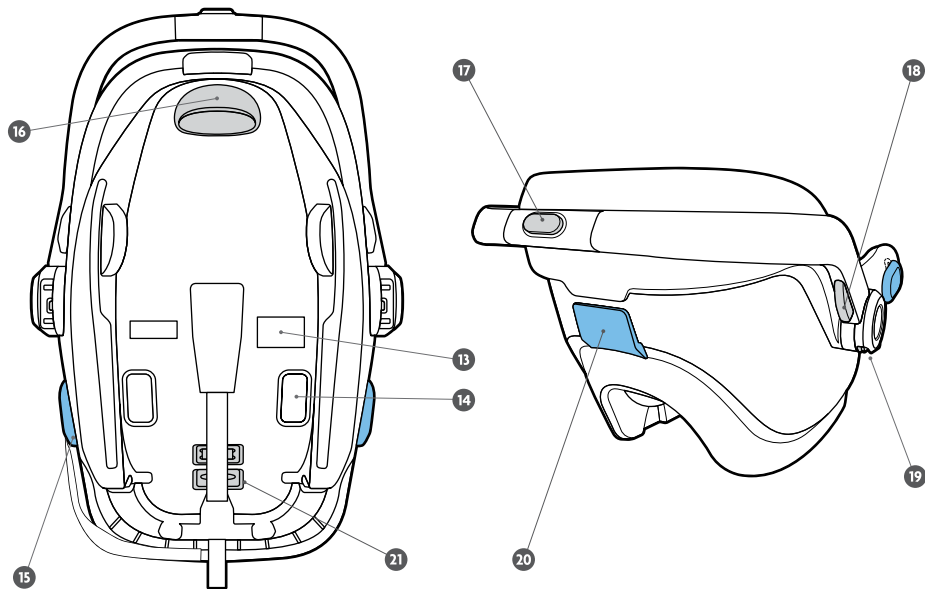

## VEHICLE COMPATIBILITY – Choosing a Vehicle Seating Location

**Please read the following information before installing this Child Restraint!**

The safest seating position is one that works best for your specific car seat, family and vehicle. When determining whether the Mesa V2 rear-facing car seat can be used with lower anchors in the rear center seating position, it is critical that you refer to your vehicle owner's instruction book. If the Mesa V2 does not install best in the rear center seating location, it is recommended to move to one of the outboard seating positions.

Before installing this child restraint you **MUST** determine the method of installation and the best vehicle seating position for that method. This child restraint can be installed either using **LATCH** or the **VEHICLE SEAT BELT**.



**ALWAYS** park on a level surface when installing a Child Restraint.

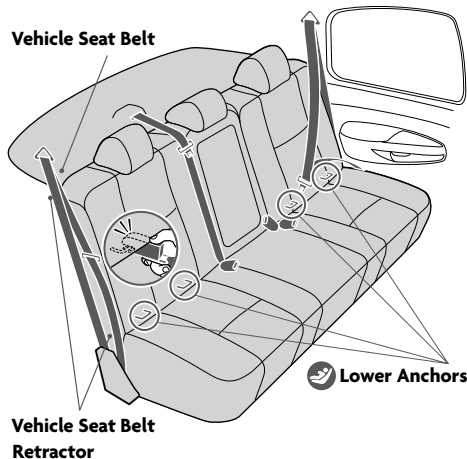

## VEHICLE COMPATIBILITY – Determining Best Installation Method

At this point take out your Vehicle owner's instruction book. You will need this to look up different features in your vehicle that might affect the installation.

**⚠️WARNING! NEVER** place a rear-facing only child restraint in front of an active airbag.

### BASE INSTALLATION

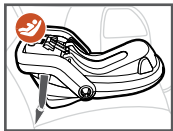

**Lower Anchor**  
(pg 24)

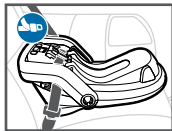

**Lap/Shoulder Belt**  
(pg 30)

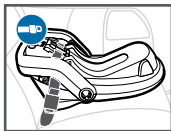

**Lap Belt Only** (pg 30)

### CARRIER INSTALLATION



**Lap/Shoulder Belt**  
Preferred Routing  
(pg 40)



**Lap/Shoulder Belt**  
Optional Routing  
(pg 40)



**Lap Belt Only**  
Routing  
(pg 40)



**NOTE:** The carry handle must be locked in the (4th) rebound position when in use.



## VEHICLE COMPATIBILITY

### LATCH (Lower Anchors and Tethers for Children)

Most vehicles manufactured after September 1, 2002 are equipped with **LATCH (Lower Anchors and Tethers for Children)**. Check your vehicle owner's instruction book to determine lower anchor compatible seating positions.

**NOTE:** No tether is required with this rear-facing carrier. Only lower anchors are used.

**NOTE:** In order to use the rear center seating position with lower anchor, the distance between the lower anchors may be up to 22" and the seating position must be approved by the vehicle manufacturer. If spacing between the lower anchors is greater than 22" or if the seating position is not approved by the vehicle manufacturer then use the vehicle seat belt for installation.

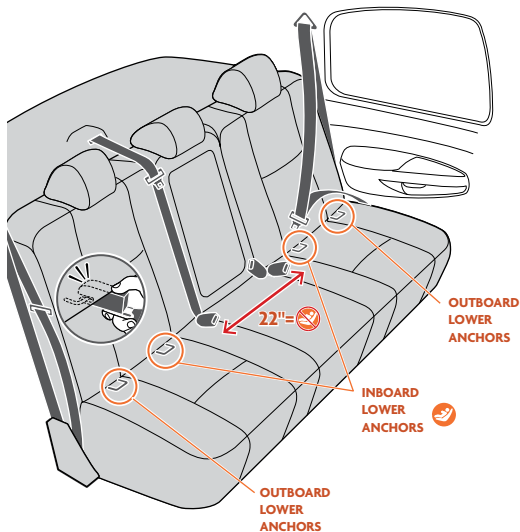

# VEHICLE COMPATIBILITY

## Overview of Vehicle Seat Belt Systems



If you do not use lower anchor to properly secure the child restraint you must use the **VEHICLE SEAT BELT SYSTEM**. Seat belt systems vary by make, model, and year of your vehicle. There are some vehicle belts that will NOT work with this child restraint or that require additional steps.

**CHECK YOUR VEHICLE OWNER'S INSTRUCTION BOOK for information regarding your vehicle seat belt system(s).**

This child restraint is compatible with most vehicle seat belt systems.

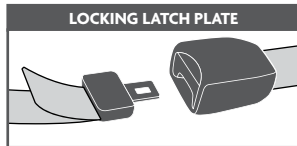
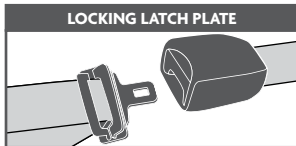
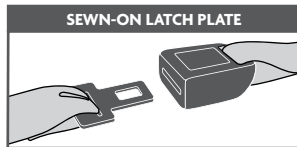
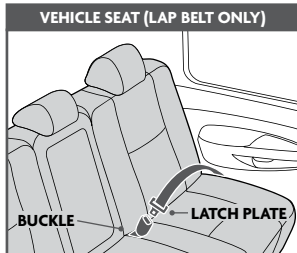
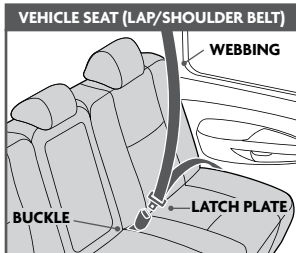

## VEHICLE COMPATIBILITY – Unsafe Vehicle Seat Belt Systems + Seating

This Child Restraint can only be installed on vehicle seats that face forward.

**DO NOT** install in seats that face to the sides or rear of the vehicle.

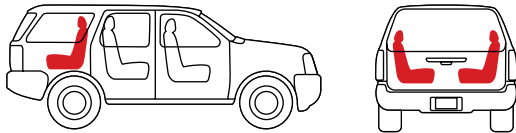

**⚠️ WARNING! DEATH OR SERIOUS INJURY CAN OCCUR.**

CHECK YOUR Vehicle instruction book for information regarding your vehicle seat belt system(s). Not all vehicle seat belts work with this Child Restraint.



## VEHICLE COMPATIBILITY – Unsafe Vehicle Seat Belt Systems + Seating

**DO NOT** use this Child Restraint with the following seat belt systems:

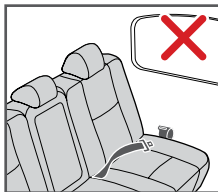

**Lap belts with  
emergency locking retractor**

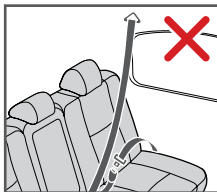

**Motorized (automatic)**

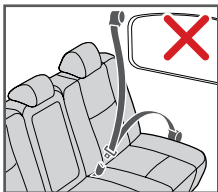

**Lap/Shoulder with  
two retractors**

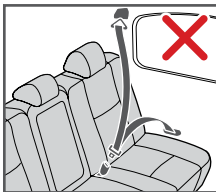

**Door mounted**

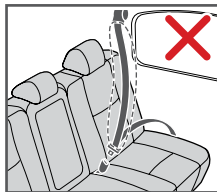

**Inflatable**



## BASE INSTALLATION WITH LOWER ANCHORS

### LEVELING THE BASE

- 1 Place the base on the vehicle seat with the adjustment foot toward the vehicle seat back.
- 2 Press the level adjust button on the top of the base to extend the foot and change the recline angle. Check the angle indicators on either side of the base. The base is level when only the **GREEN** marker is visible between the two arrows. No **RED** should be visible.



**NOTE:** Vehicle must be parked on a level surface to properly level the base.

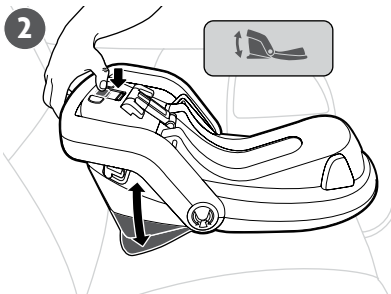
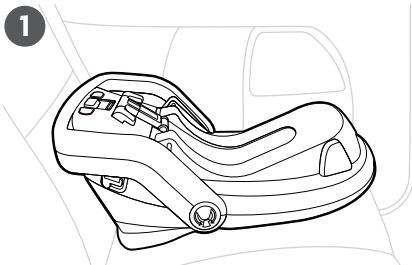
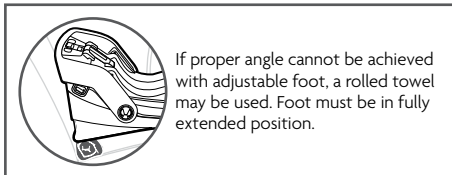

## BASE INSTALLATION WITH LOWER ANCHORS

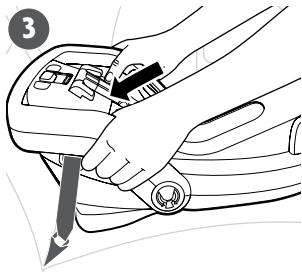
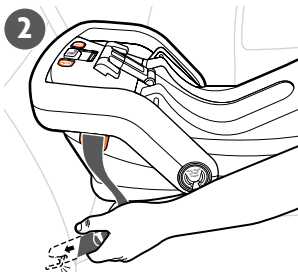
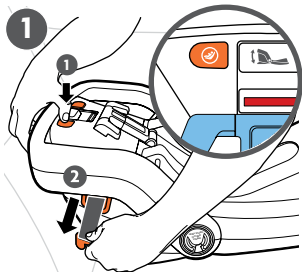

- 1 Locate the lower anchor connectors on either side of the base and remove by pushing the corresponding orange button on the top of the base ① while pulling the connector out of the lower anchor storage pocket ②.
  - 2 Attach the lower anchor connectors to the vehicle lower anchors located in the vehicle seat bight (crease of seat).
- NOTE:** Check lower anchor connectors are in the upright position.
- 3 Apply pressure firmly into the base allowing all the excess lower anchor connector webbing to retract and tighten.



Push into the seat bight (crease of seat). Installation is complete when tightness indicator turns from **RED** to **GREEN** and stays **GREEN** when downward push is discontinued.

**REVIEW SAFETY CHECK ON PAGE 28.**

ALL STEPS MUST BE ACHIEVED.



## BASE INSTALLATION WITH LOWER ANCHORS

### What is a Waterfall?

Many late model vehicles have what industry professionals call a waterfall. A waterfall is the wedge of material where your vehicle seat cushion and seat back meet. In some cases, this may interfere with the leveling foot on your UPPAbaby Mesa, preventing it from 'sitting' properly in the crease of the vehicle seat.

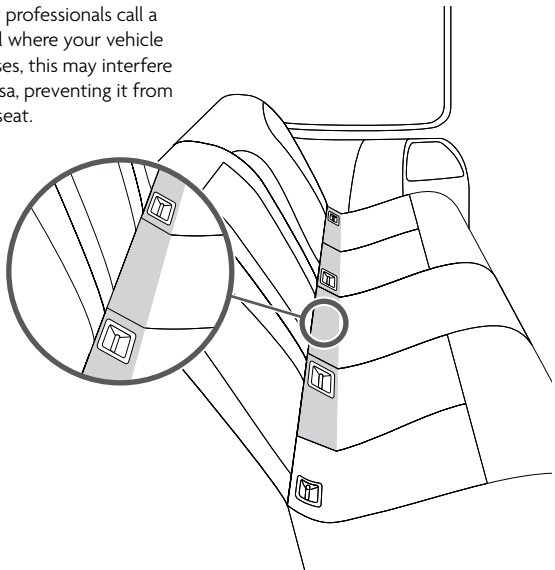

## BASE INSTALLATION WITH LOWER ANCHORS

### What is a Waterfall?

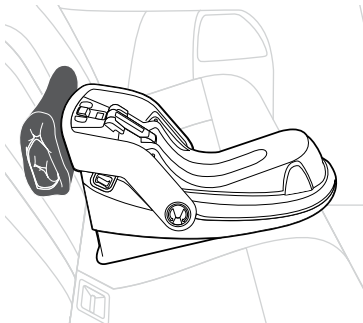

This is an easy issue to resolve by following the steps below:

- 1 Uninstall your Mesa base.
- 2 Adjust the level adjustment foot to achieve proper recline level.  
**NOTE:** The level angle indicator is located on either side of the Mesa base. It **MUST** be all **GREEN**. In cases where a waterfall is present, we recommend extending the foot to its **HIGHEST** position.
- 3 Push the base into the seat back. If there is a gap between the top of the Mesa base and the back of the vehicle seat, place a rolled hand towel in the gap flush with the top of the base.
- 4 Proceed to **BASE INSTALLATION WITH LOWER ANCHORS** (pg 25). Follow Safety Check (pg 28) to confirm proper installation.



## BASE INSTALLATION WITH LOWER ANCHORS – Safety Check

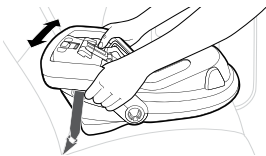

Base doesn't move more than 1" side-to-side and front-to-back at the belt path. Lower anchor connector webbing is secure and untwisted.

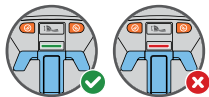

Ensure tightness indicator is **GREEN** after each use. If it is not, apply pressure by pushing base into seat bight (crease of seat) to tighten.



Recline angle is correct. Base is level when only **GREEN** is visible between the two arrows on the level indicator. No **RED** should be visible.

## BASE INSTALLATION WITH LOWER ANCHORS

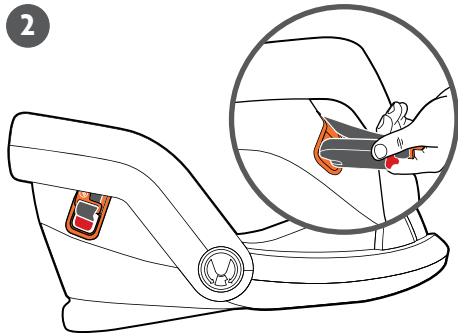
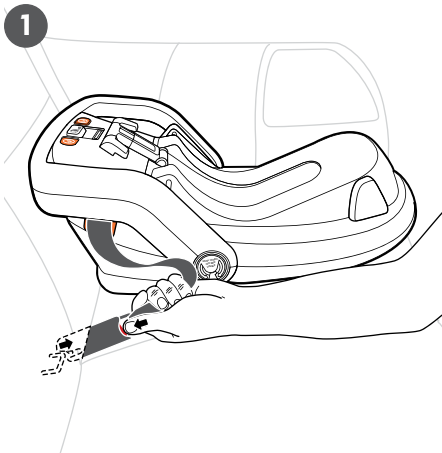

### UNINSTALLING THE BASE

- 1 Press the **RED** button on the lower anchor connector while pulling the connector off the vehicle anchor.
- 2 Store lower anchor connectors in designated housing found on each side of the base.



## BASE INSTALLATION WITH VEHICLE SEAT BELT

### LEVELING THE BASE

- 1 Place the base on the vehicle seat with the adjustment foot toward the vehicle seat back.
- 2 Press the level adjust button on the top of the base to extend the foot and change the recline angle. Check the angle indicators on either side of the base. The base is level when only the **GREEN** marker is visible between the two arrows. No **RED** should be visible.



**NOTE:** Vehicle must be parked on a level surface to properly level the base.

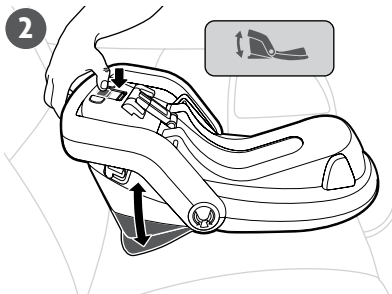
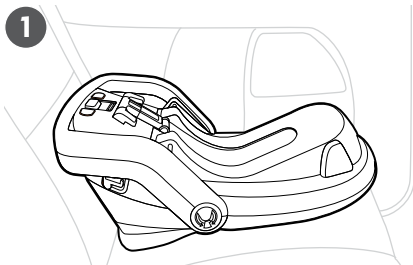
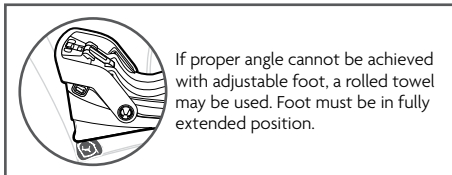



## BASE INSTALLATION WITH VEHICLE SEAT BELT



**PROCEED TO CHOSEN INSTALLATION METHOD:**

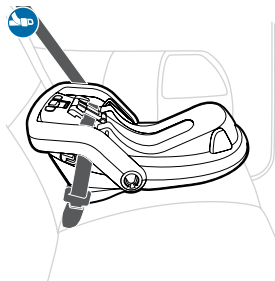

**LAP/SHOULDER  
ROUTING METHOD**

PAGE 32

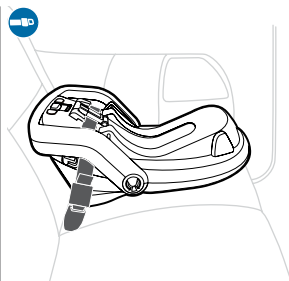

**LAP BELT ONLY  
ROUTING METHOD**

PAGE 34



## BASE INSTALLATION WITH VEHICLE SEAT BELT

### Lap/Shoulder Belt Routing Method

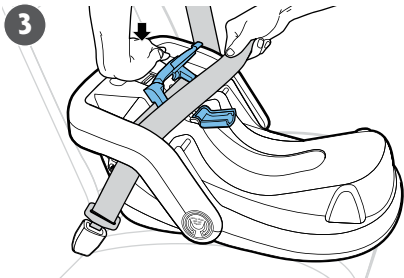
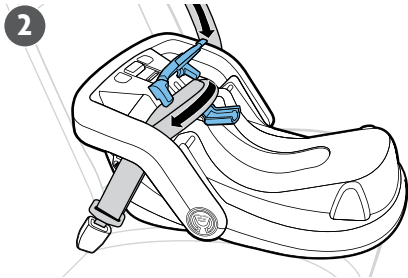
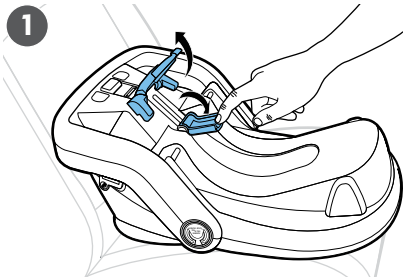

- 1 Open lock-off.
- 2 Route the vehicle belt through the vehicle belt path while guiding the lap portion of the belt as close as possible to the top of the lock-off where the door hinges. Buckle the vehicle belt.
- 3 Hold shoulder portion of belt above base. With one hand, push down base in the direction of the seat bight (crease of seat) and hold firm as you pull shoulder belt.

## BASE INSTALLATION WITH VEHICLE SEAT BELT

### Lap/Shoulder Belt Routing Method

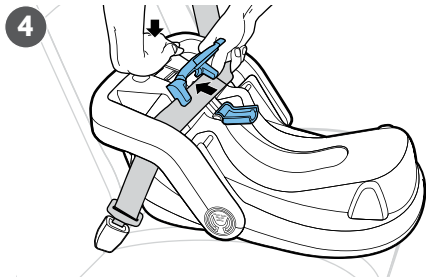

- 4 While holding taut, slide shoulder belt back through the belt path as close as possible to the top of the lock-off.

**NOTE:** Tightness indicator should be **GREEN**.

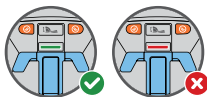

- 5 Close the top section of the lock-off over the lap/shoulder belt ①. Second, close the bottom section of the lock-off over the belt ②. Make sure you push the bottom of the lock-off all the way down until you hear an audible click.

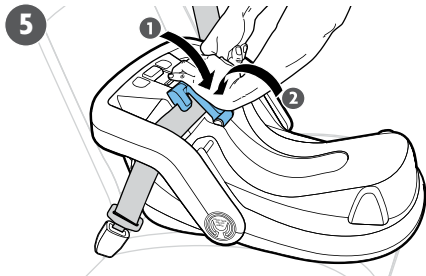

**REVIEW SAFETY CHECK ON PAGE 38.**  
ALL STEPS MUST BE ACHIEVED.



## BASE INSTALLATION WITH VEHICLE SEAT BELT

### Lap Belt Only Routing Method

- 1 Open lock-off.
- 2 Route the vehicle belt through the belt path while guiding the lap portion of the belt as close as possible to the topside of the lock-off where the door hinges. Buckle the vehicle.

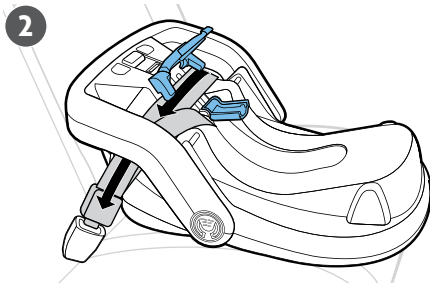
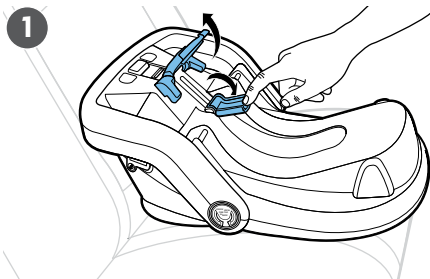

## BASE INSTALLATION WITH VEHICLE SEAT BELT

### Lap Belt Only Routing Method

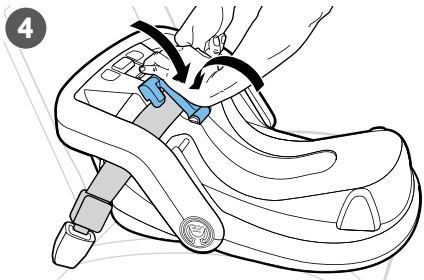
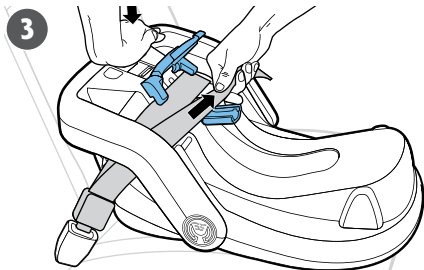

- 3 With one hand push down base and hold firm as you pull lap belt to tighten and remove any slack.

**NOTE:** Tightness indicator should be **GREEN**.

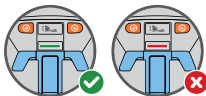

- 4 Close the top section of the lock-off over the belt then close the bottom section of the lock-off over the belt. Make sure you push the bottom of the lock-off all the way down until you hear an audible click.

**NOTE:** Before closing the lock-off door, make sure the vehicle seat belt has not slipped down into the belt path and is as close as possible to the topside of the lock-off where the door hinges.

**REVIEW SAFETY CHECK ON PAGE 38.**  
ALL STEPS MUST BE ACHIEVED.



## BASE INSTALLATION WITH VEHICLE SEAT BELT

### What is a Waterfall?

Many late model vehicles have what industry professionals call a waterfall. A waterfall is the wedge of material where your vehicle seat cushion and seat back meet. In some cases, this may interfere with the leveling foot on your UPPAbaby Mesa, preventing it from 'sitting' properly in the crease of the vehicle seat.

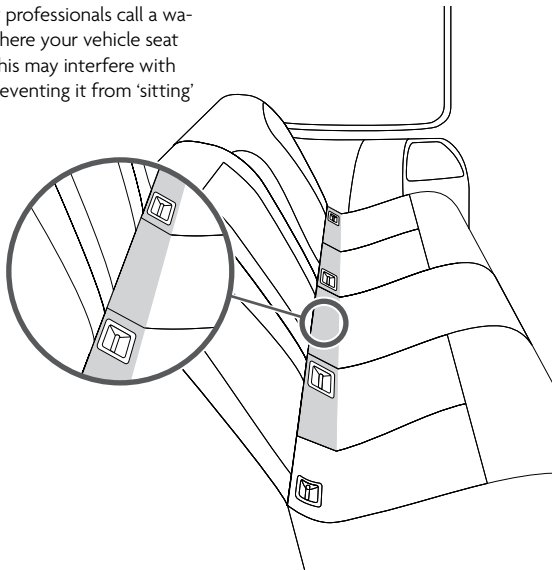

## BASE INSTALLATION WITH VEHICLE SEAT BELT

### What is a Waterfall?

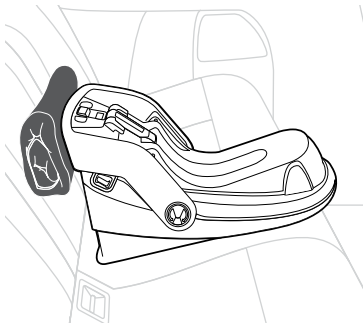

This is an easy issue to resolve by following the steps below:

- 1 Uninstall your Mesa base.
- 2 Adjust the level adjustment foot to achieve proper recline level.
- 3 **NOTE:** The level angle indicators are located on either side of the base and bubble must be within the lines. In cases where a waterfall is present, we recommend extending the foot to its HIGHEST position.
- 4 Push the base into the seat back. If there is a gap between the top of the Mesa base and the back of the vehicle seat, place a rolled hand towel in the gap flush with the top of the base.
- 5 Proceed to **BASE INSTALLATION WITH VEHICLE SEAT BELT** (pg 32 or 34) based on your method of installation). Follow Safety Check (pg 38) to confirm proper installation.



## BASE INSTALLATION WITH VEHICLE SEAT BELT

### Safety Check

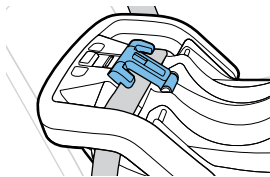

Lock-off must be used at all times when installing with a vehicle seat belt.  
Vehicle Belt is secure and untwisted.  
Base doesn't more than 1" side-to-side and front-to-back at the belt path.

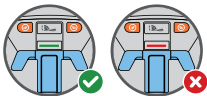

Ensure tightness indicator is **GREEN** after each use. If it is not, reinstall base.



Recline angle is correct. Base is level when only **GREEN** is visible between the two arrows on the level indicator. No **RED** should be visible.





### UNINSTALLING THE BASE

- 1 Unbuckle seat belt.
- 2 Open lock-off.
- 3 Remove seat belt.

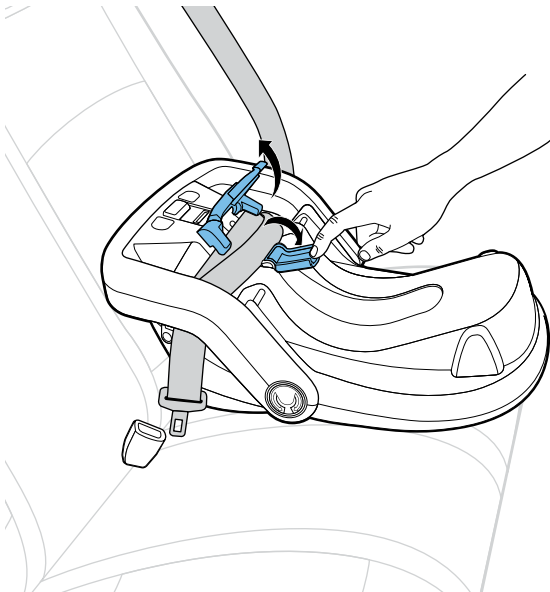



## CARRIER INSTALLATION WITH VEHICLE SEAT BELT

### DETERMINING BEST INSTALLATION METHOD

There are (3) methods of carrier only installation:

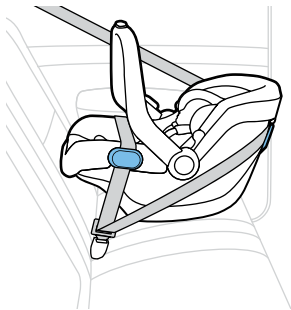

#### LAP/SHOULDER PREFERRED ROUTING METHOD

Installation with both  
the lap and shoulder belt

PAGE 42



#### LAP/SHOULDER OPTIONAL ROUTING METHOD

Installation with both  
the lap and shoulder belt.

PAGE 44

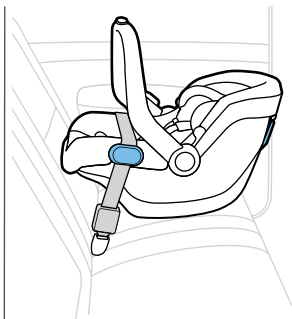

#### LAP BELT ONLY ROUTING METHOD

No shoulder belt is used.  
This method applies to vehicle with no  
shoulder belt and aircraft.

PAGE 46

## CARRIER INSTALLATION WITH VEHICLE SEAT BELT



1

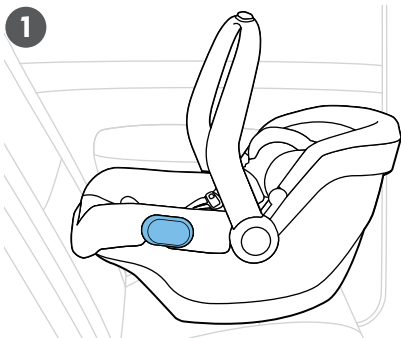

2

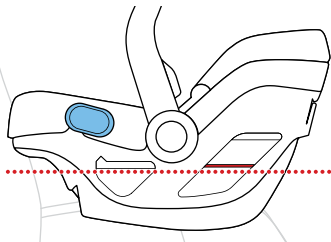

### LEVELING THE CARRIER

- 1 Place the carrier rear-facing on the vehicle seat.
- 2 Make sure the vehicle is parked on level ground and the **RED** line on the carrier is level to the vehicle floor.



For a more stable installation, a rolled towel may be used.



## CARRIER INSTALLATION WITH VEHICLE SEAT BELT

### Lap/Shoulder Belt Preferred Routing Method

If shoulder belt does not route around the back of the Mesa V2 carrier, follow  
**LAP/SHOULDER BELT OPTIONAL ROUTING METHOD** PAGE 44

- 1 Route the lap portion of the seat belt through both lap belt guides on the carrier and buckle the seat belt.
- 2 Route belt around the seat back through the rear belt guide.

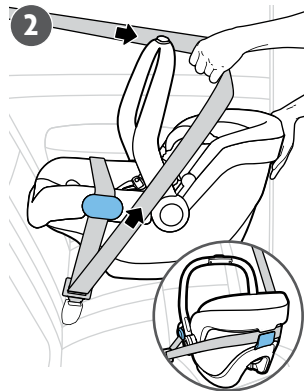
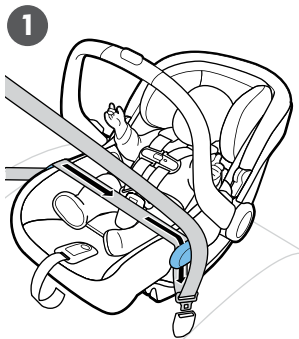

**⚠ WARNING!** Vehicle seat belt must lock, otherwise locking clip must be used. See page 47 for instructions.

## CARRIER INSTALLATION WITH VEHICLE SEAT BELT

### Lap/Shoulder Belt Preferred Routing Method

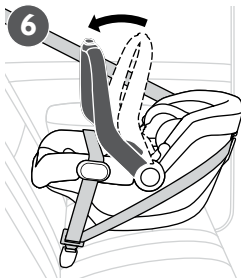
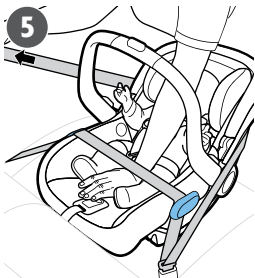
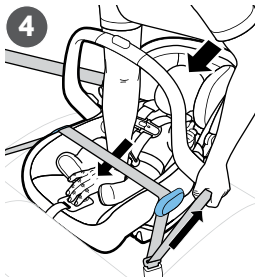
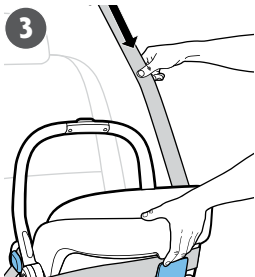

- 3 Lock vehicle seat belt.

**NOTE:** See vehicle owner's instruction book for more information on locking your seat belt for child restraint installations.

- 4 Push the carrier into the vehicle seat bight (crease of the seat) and gently apply pressure from behind the carrier into the vehicle seat back. At the same time, pull on the shoulder portion of the vehicle belt closest to the buckle and hold tightly.

**NOTE:** Be mindful of canopy.

- 5 Feed excess webbing into the vehicle retractor.
- 6 Rotate carry handle forward to the (4th) rebound position when in use.

**NOTE:** Check that the carrier is still properly leveled.

**REVIEW SAFETY CHECK ON PAGE 48.**  
ALL STEPS MUST BE ACHIEVED.



## CARRIER INSTALLATION WITH VEHICLE SEAT BELT

### Lap/Shoulder Optional Routing Method

- 1 Route the lap portion of the seat belt through both lap belt guides on the carrier and buckle the seat belt.
- 2 Lock vehicle seat belt. See vehicle owner's instruction book for more information on locking your seat belt for child restraint installations.
- 3 Push the carrier into the vehicle seat bight (crease of the seat) and gently apply pressure from behind the carrier into the vehicle seat back. At the same time, pull on the shoulder portion of the vehicle seat belt closest to the buckle and hold tightly.

**NOTE:** Be mindful of canopy.

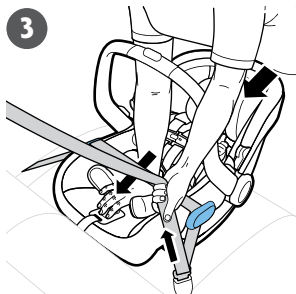
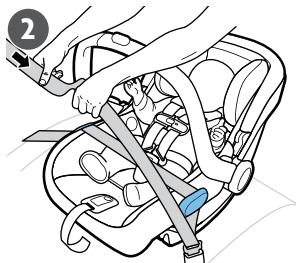
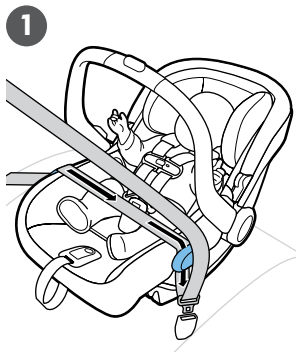

**⚠ WARNING!** Vehicle seat belt must lock, otherwise locking clip must be used. See page 47 for instructions.

## CARRIER INSTALLATION WITH VEHICLE SEAT BELT

### Lap/Shoulder Optional Routing Method

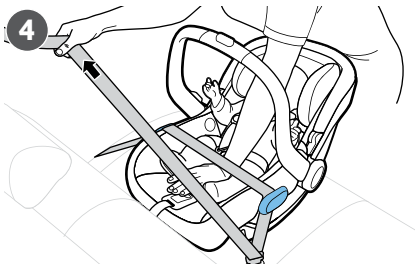

- 4 Feed excess webbing into the vehicle retractor.
- 5 Rotate carry handle forward to the (4th) rebound position when in use.

**NOTE:** Check that the carrier is still properly leveled.

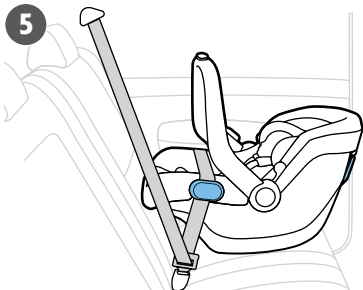

**REVIEW SAFETY CHECK ON PAGE 48.**  
ALL STEPS MUST BE ACHIEVED.



## CARRIER INSTALLATION WITH VEHICLE SEAT BELT

### Lap Belt Only Routing Method

1

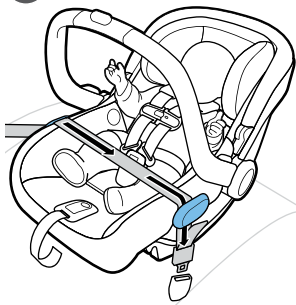

2

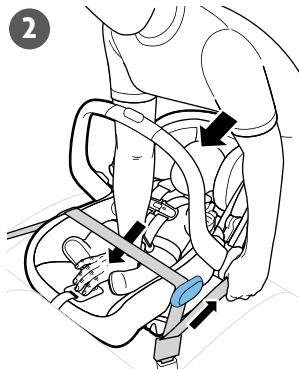

3

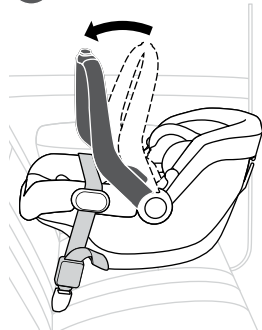

- 1 Route the lap belt through both guides on the carrier and buckle the seat belt.
- 2 Push the carrier into the vehicle seat bight (crease of the seat) and gently apply pressure from behind the carrier into the vehicle seat back. At the same time, pull on the looser portion of the lap belt closest to the buckle and hold tightly.  
**NOTE:** Be mindful of canopy.
- 3 Rotate carry handle forward to the (4th) rebound position when in use.  
**NOTE:** Check that the carrier is still properly leveled.

**REVIEW SAFETY CHECK  
ON PAGE 48.**  
ALL STEPS MUST BE ACHIEVED.



## CARRIER INSTALLATION WITH VEHICLE SEAT BELT



The locking clip can be found on the underside of the base (page 15). The locking clip can be used for **CARRIER** installation with Lap/Shoulder belt combination when the seat belt does not lock.

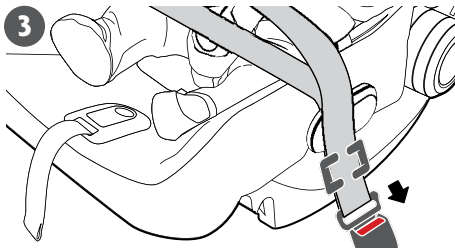
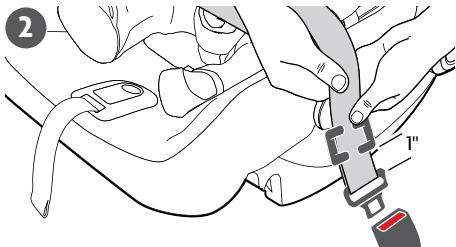
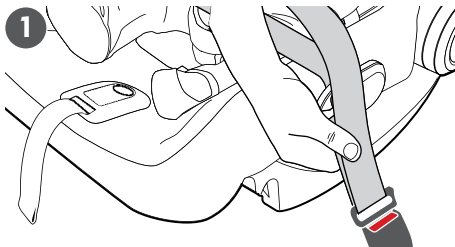

### INSTALLATION WITH LOCKING CLIP

- 1 While pushing into the child restraint, pull the seat belt tight to eliminate any slack then pinch both pieces of seat belt webbing directly behind the latch plate. Unbuckle the belt without letting the webbing slip.
- 2 Thread the locking clip onto both lap and shoulder belts 1" from the latch plate.
- 3 Re-buckle the vehicle belt.



## CARRIER INSTALLATION WITH VEHICLE SEAT BELT

### Safety Check

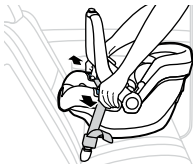

Carrier doesn't move more than 1" side to side and more than 1" front-to-back at the belt path.

---

Vehicle belt is secure and untwisted.

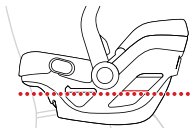

Angle is correct when The **RED** line on the carrier is level with the vehicle floor.

---

Seating position is permitted by both UPPAbaby and your vehicle manufacturer for use with the type of Vehicle Seat Belt.

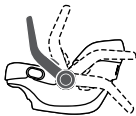

The carry handle must be locked in the (4th) rebound position when in use.

# CARRIER INSTALLATION WITH VEHICLE SEAT BELT

## Aircraft Installation



### **THIS CHILD SEAT IS CERTIFIED FOR AIRCRAFT USE.**

UPPAbaby and The FAA recommend that a child weighing up to 40 lbs (18 kg) use a certified harnessed child seat while traveling on an aircraft. Contact the airline about their policy prior to traveling.

### **AIRCRAFT INSTALLATION**

When installing this child restraint on an airplane, install the same way as **CARRIER INSTALLATION WITH VEHICLE SEAT BELT/LAP BELT ONLY ROUTING METHOD** (PAGE 46).

**NOTE:** Make sure that the aircraft buckle does not interfere with the belt guides on the infant carrier.

**⚠️ WARNING! DO NOT** use base with aircraft installation. Only the carrier is certified for aircraft use. Inflatable seat belts are not compatible with this child restraint.

### **SAFETY REMINDERS AND TIPS**

- Notify the airline ahead of time that you'll be traveling with a child restraint.
- Install this carrier in a window seat to avoid blocking the aisle.
- Ask for a seat belt extender if the lap belt is too short.
- Use only on a forward-facing aircraft seat.
- DO NOT use this restraint if a secure installation cannot be achieved.
- Place carry handle in any of the (4) locked positions for use in the aircraft as long as it doesn't interfere with the back of the seat in front of the carrier.

## GENERAL USE – SIP Carriage + Harness Positioning

This child restraint has an adjustable head restraint and no-rewthread harness system that is easy to adjust to properly secure the child.

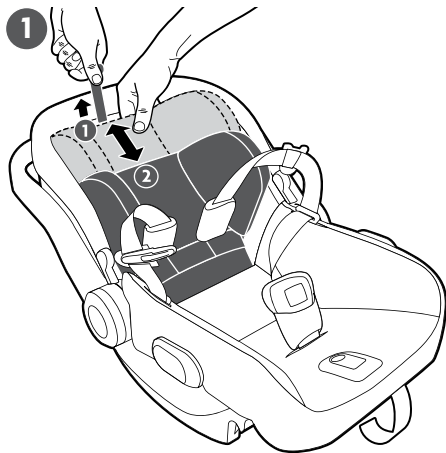

- 1 Adjust the head restraint by pulling on the adjuster tab **1** and sliding the head restraint up or down **2**.
- 2 Position the head restraint so the harness rests at the child's shoulders or slightly below.

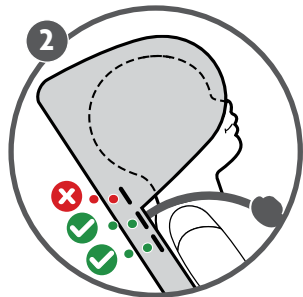

## GENERAL USE – Securing Your Child

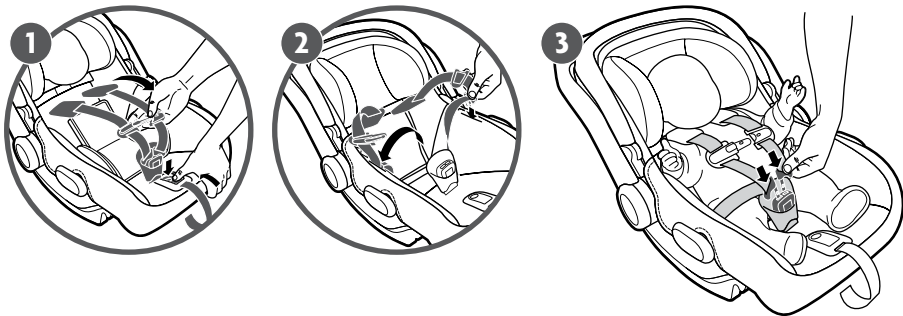

- 1 Loosen the harness by pressing on the harness adjuster release button and pulling out the shoulder straps.
- 2 Open the retainer clip, unbuckle the harness, and tuck the latch plates into the side pockets to hold harness open.
- 3 Place infant in child restraint making sure their body is making full contact with the seating surface. Place harness over child and insert buckle tongues into the buckle until a “click” is heard. Pull up on the buckle tongues to make sure they are locked.

**NOTE:** See page 53 on crotch belt positions. The child should not be sitting on top of the buckle.

**⚠️ WARNING! NEVER** use non-regulated products with this child restraint, unless approved by UPPAbaby.

## GENERAL USE – Securing Your Child

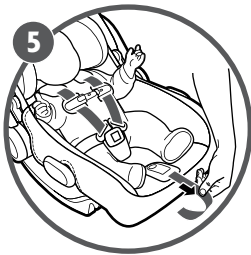

### **HARNESS SHOULD BE SNUG.**

Pinch harness webbing at child's shoulders. If you can pinch webbing, the harness is too loose and should be tightened. For smaller babies, it is recommended to remove the harness pads for a more secure fit.

- 4 Pull up on the harness to remove excess slack around the child's legs.
  - 5 Pull the harness adjuster strap to snugly adjust the harness straps around your child.
  - 6 Close retainer clip and position at armpit level. Make sure the shoulder pads don't interfere with positioning the chest clip.
- NOTE:** See page 53 on crotch belt positions. The child should not be sitting on top of the buckle.

## GENERAL USE – Crotch Belt Positions

The crotch belt and buckle has two use positions. Always position the buckle and crotch strap in the slot closest to the child. If the child is on top of the buckle in the inner position, then adjust the buckle to the outer position.

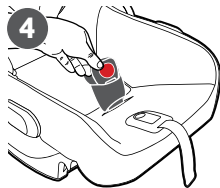
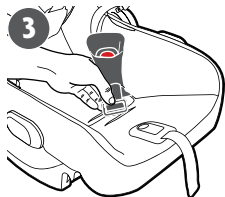
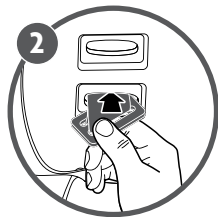
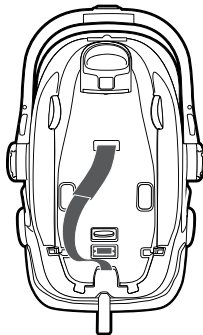
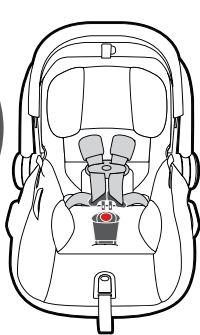
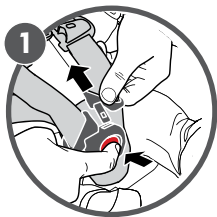

- 1 Unbuckle the harness.
- 2 Flip carrier over, insert the metal clip completely through the shell and seat pad.
- 3 Locate the appropriate buckle slot and insert from the top completely through the slot on the seat pad and shell.
- 4 Check that buckle is securely attached by pulling up on buckle.

## GENERAL USE – Infant Insert

To ensure a better fit for smaller infants, the infant insert is recommended between **4 and 11 lbs.**

This Infant Insert was designed to optimize fit and body positioning for your child. When you can achieve all fit criteria without the insert, it can be removed.

**NOTE:** You may continue use beyond 11 lbs until all criteria are being met:

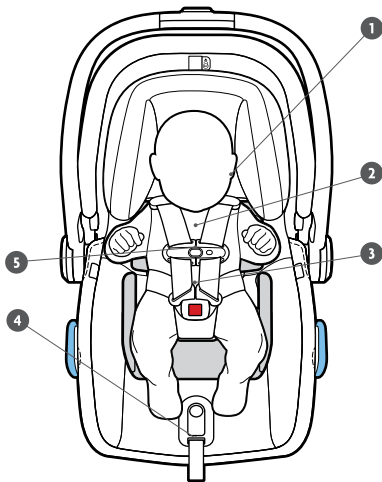

- 1 Harness straps are at or slightly below shoulders

**NOTE:** Harness pads are optional. They must be removed when securing a preemie.

- 2 Chest clip is at armpit level
- 3 Crotch buckle rests securely against child with no gaps and child is not sitting on top of the buckle

**NOTE:** Crotch buckle pad is optional.

- 4 Room to tighten harness properly
- 5 Child is not slouching

**NEVER** use non-regulated products with this child restraint, unless approved by UPPAbaby.



## GENERAL USE – Attaching Carrier to Base

- 1 Place carrier on base until a click is heard.
- 2 Check for a secure connection by pulling up on carry handle.

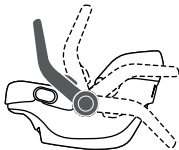

Carry handle must be locked in the (4th) rebound position when in use in the vehicle.

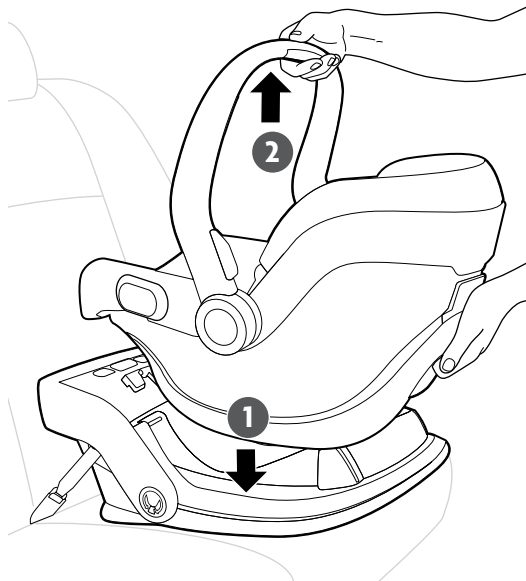

## GENERAL USE – Releasing Carrier from Base

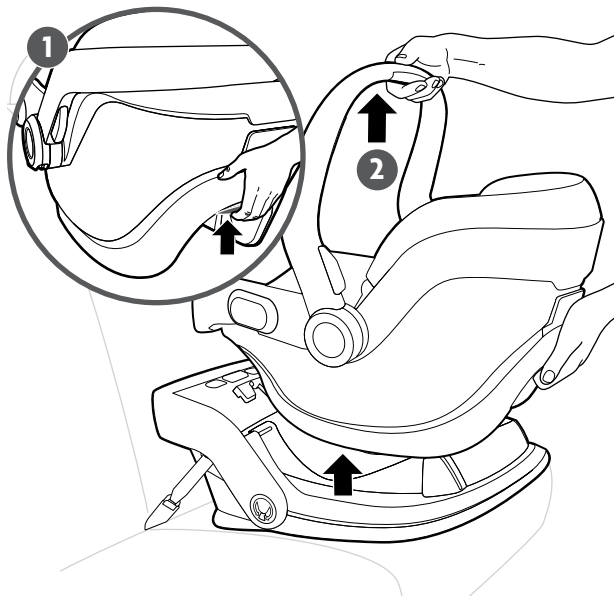

- 1 Pull and hold carrier release button on back of the carrier.
- 2 Lift carrier off base.

## GENERAL USE – Using Canopy

Canopy easily adjusts to one of three (3) positions.

### TO EXTEND CANOPY

Slowly pull forward on main canopy frame until resting in desired position.

### TO RETRACT/STOW CANOPY

Gently push downward on main canopy frame allowing the center support and canopy fabric to guide into the storage compartment in carrier.

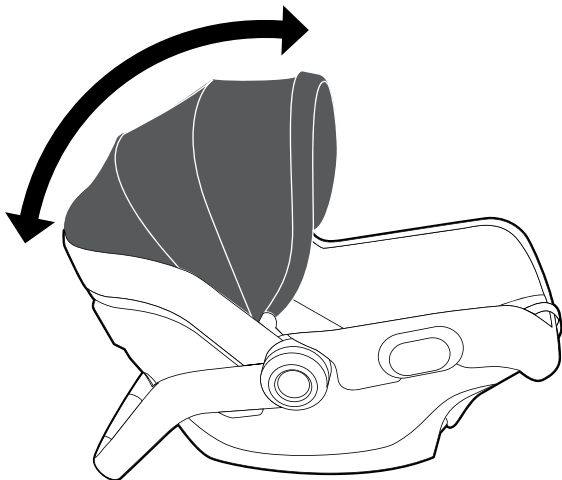

## GENERAL USE – Using Carry Handle

To adjust the carry handle position, squeeze both handle adjustment buttons and rotate forward or backward.

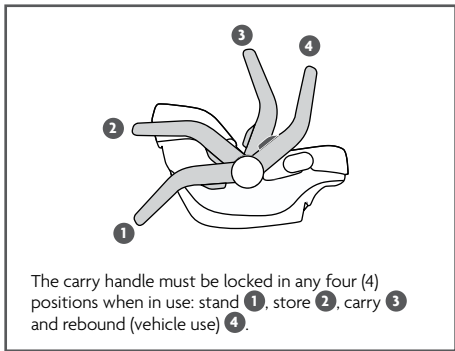
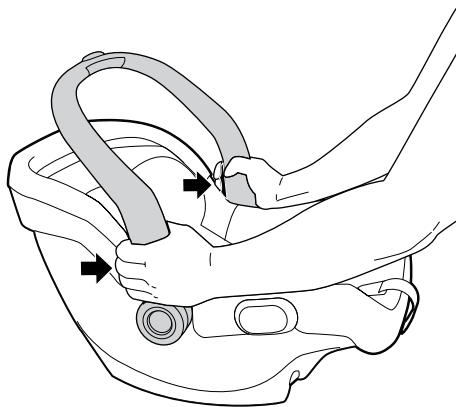

**⚠ WARNING! NEVER** use non-regulated products with this child restraint, unless approved by UPPAbaby.

## GENERAL USE – Important Checks

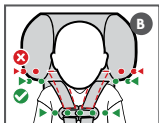
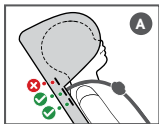

- This child restraint is for rear-facing use only.
- The seat must be tightly installed in a forward-facing vehicle seat.
- The harness should be at the shoulders or slightly below **A**.
- Retainer clip must be at armpit level and harness straps should be snug **B**.
- The top of child's head should not be less than 1" from the top of the headrest when in its highest position.
- The child must weigh between 4 and 35 pounds and be no taller than 32".
- The back seat is the safest place for children aged 12 and under.
- **NEVER** use non-regulated products with this child restraint, unless approved by UPPAbaby.
- **NEVER** place in front of an active airbag.
- Install using lower anchor or the vehicle seat belt, not both.
- **DO NOT** secure an infant in the carrier with extra material, bulky clothing, or extra padding. Instead place a blanket over the harness after properly securing the child **C**.
- Carry handle must be locked in any of the (4) handle positions outside of the vehicle. While in the vehicle, the carry handle must be in the furthest forward position.
- Adjust base to the appropriate angle by using the grey button on top between the two orange buttons. The angle indicator on the sides of the base should be **GREEN**, or the level line on the carrier should be level to the ground
- Always check the tightness indicator is **GREEN** after each use.
- Always secure an unoccupied child restraint; in a crash an unsecured infant car seat may injure occupants in your vehicle.

## STROLLER COMPATIBILITY – Fitting Carrier to Stroller Frame

Prior to fitting Mesa V2 carrier to stroller frame, engage brake on stroller and remove toddler seat from frame.

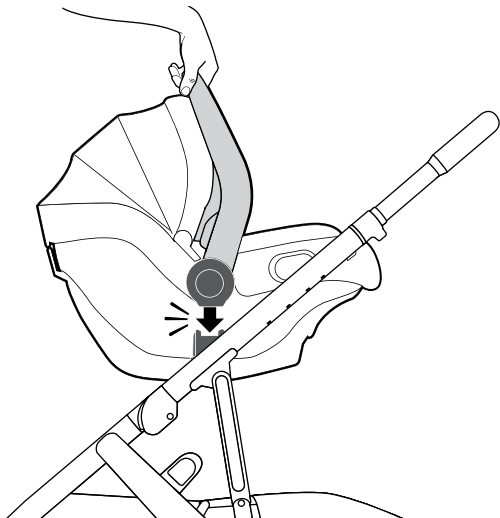

- 1 With carrier facing stroller handle, align carrier handle hubs with attachment posts on stroller.
- 2 Let carrier slide onto attachment posts. An audible click indicates proper attachment.
- 3 Lift up on car seat handle to check attachment.

### **COMPATIBLE WITH:**

Vista V2, Vista 2015+, Cruz V2, Cruz

Compatible with Ridge and Minu strollers with use of adapters specific to each model.

## STROLLER COMPATIBILITY – Releasing Carrier from Stroller Frame

- 1 Engage and hold the stroller release button on the top of the carry handle.
- 2 Lift the carrier off stroller frame.

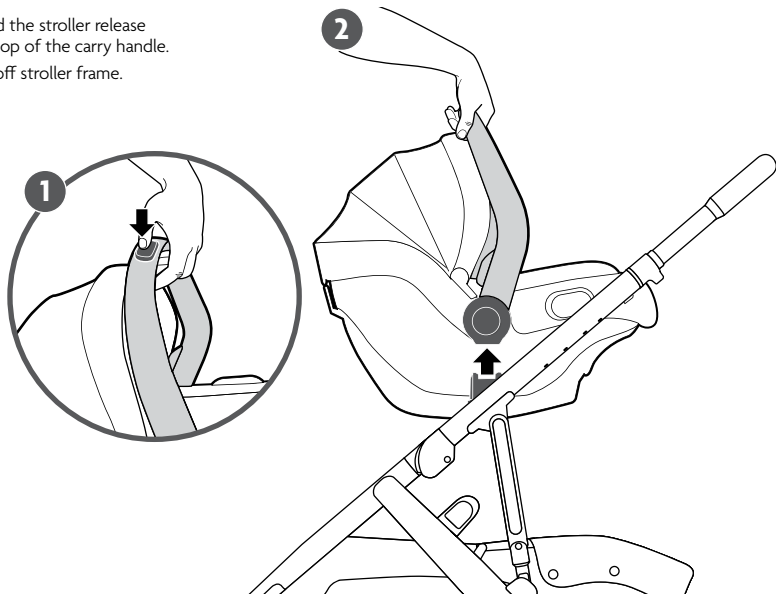

## CARE + MAINTENANCE – Cleaning

### CLEANING FABRICS

Fabrics include: seat pad, infant inserts, buckle pads and shoulder pad.



Machine wash in cold water on gentle cycle with mild detergent. **DO NOT** bleach.



Dry flat and away from direct sunlight before re-use or storage.



**DO NOT** iron or dry clean.

### CLEANING HARNESS WEBBING + CANOPY



Spot clean using warm water with mild detergent. **DO NOT** bleach.



Air dry completely before re-use or storage.

### CLEANING PLASTIC



Spot clean using warm water with mild detergent. **DO NOT** bleach.



Towel dry completely before re-use or storage.

Cleaning Buckle and **LOWER ANCHOR CONNECTOR** hardware - Buckle should fasten with a “click”. If not, rinse under warm running water. **DO NOT** use detergents or lubricants.



## CARE + MAINTENANCE – SIP Padding Removal

Following are fabric removal instructions for cleaning.

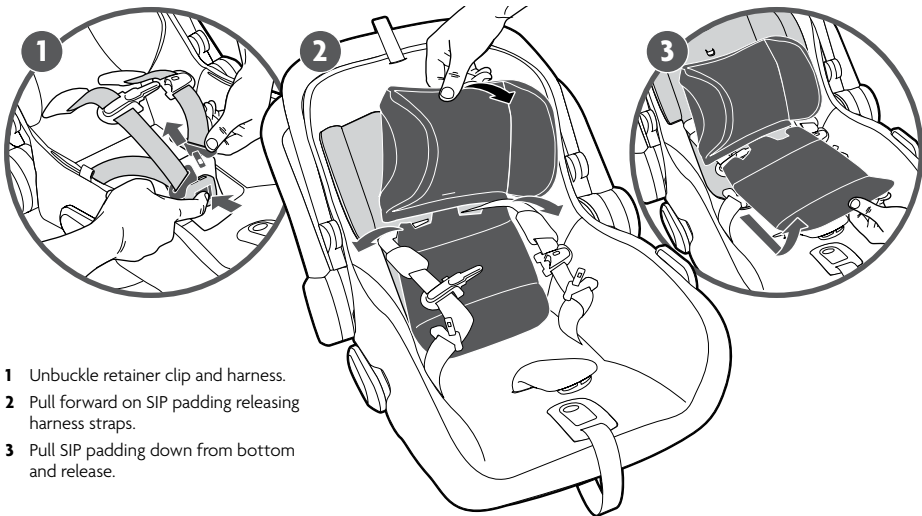

- 1 Unbuckle retainer clip and harness.
- 2 Pull forward on SIP padding releasing harness straps.
- 3 Pull SIP padding down from bottom and release.

## CARE + MAINTENANCE – Seat Padding Removal

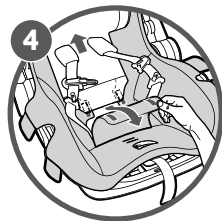
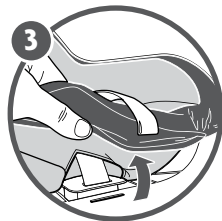
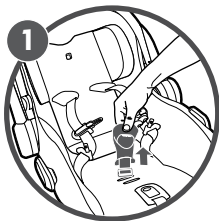

- 1 Remove buckle cover.
- 2 Remove (4) plastic tabs from front sides of carrier.
- 3 Loosen padding from front end of carrier and free padding from around harness adjuster release button housing.
- 4 Raise SIP to highest position and pull back padding panel.

## CARE + MAINTENANCE – Seat Padding Removal

- 5 Slide SIP to lowest position and release (2) plastic tabs from upper portion of carrier.
- 6 Thread SIP adjuster tab through buttonhole in top of seat pad.
- 7 Pull seat padding up and forward to remove padding around SIP.

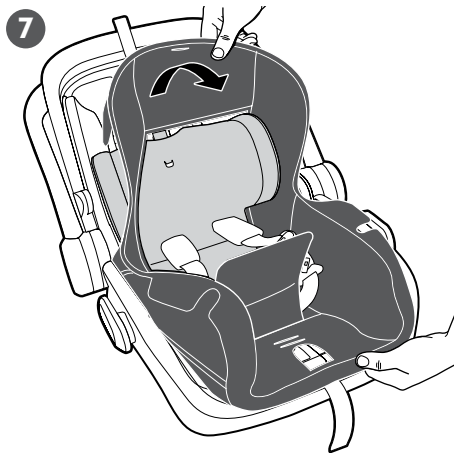
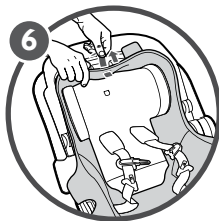
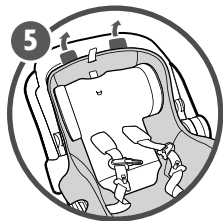

## CARE + MAINTENANCE – Seat Padding Installation

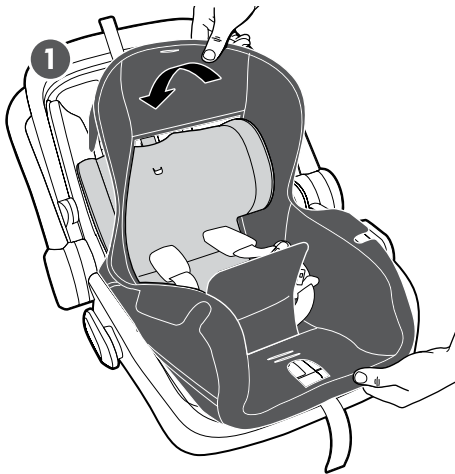

- 1 With the SIP in the lowest position, lay seat pad over carrier, open Velcro® flap and fit opening around SIP/headrest.
- 2 Tuck top 2 tabs into designated slots and pull headrest adjuster tab through buttonhole
- 3 Lift lower part of SIP and pull harness straps to each side of opening. Secure padding panel with Velcro®.

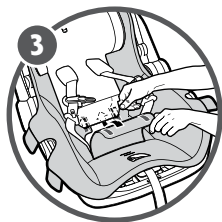
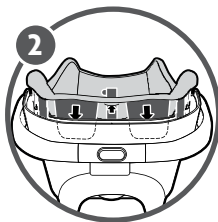

## CARE + MAINTENANCE – Seat Padding Installation

- 4 Raise SIP/headrest into highest position.
- 5 Pull harness adjuster strap through opening in seat pad and install pad around adjuster release button housing.
- 6 Wrap padding around front lip and install 4 lower plastic tabs.

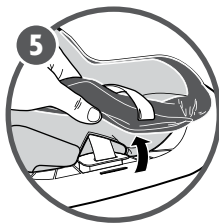

## CARE + MAINTENANCE – SIP Padding Installation

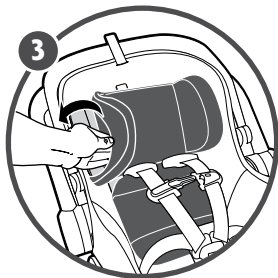
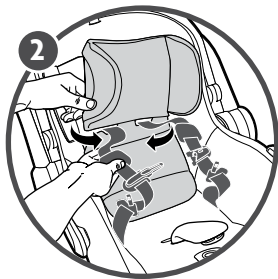

- 1 Insert lower part of SIP carriage into pocket on the back of SIP padding.
- 2 Guide harness straps back into slots in SIP padding.
- 3 Secure SIP cover tightly around SIP ears.

## WARRANTY



Welcome to the UPPAbaby family! We are with you for the long haul. Register your car seat within three months to claim your Limited Lifetime Warranty\*.

**Register your product at: [uppababy.com/register](http://uppababy.com/register)**

\*Lifetime warranty applies to UPPAbaby car seats and only the original owner, within the lifetime of the product. To receive your Limited Lifetime Warranty, you **MUST** register your car seat within three months of purchase and provide a valid purchase receipt from an authorized UPPAbaby retailer. The “lifetime” of the product is defined as the period of use by the registrant for use with his/her children up to 7 years from date of manufacture.

Your UPPAbaby product is warranted to be free from any manufacturing defects for a period of 2 years from the date of purchase under normal use and in compliance with the operating instructions.

This warranty is not transferable and extends only to the original retail purchaser and is only valid when supplied with proof of purchase from an authorized retailer. Proof of purchase must be retained for this warranty.

The warranty is valid only in the original country of purchase. This warranty is subject to the conditions set forth by country in which the items were purchased. Conditions may vary. UPPAbaby will not ship replacement or repair parts out of the country of purchase.

UPPAbaby will provide replacement parts or conduct repairs as determined fitting by the company. UPPAbaby reserves the right to exchange item with a replacement part. Some parts may be replaced with newer model parts as the product is improved over time.

## WARRANTY

This warranty does not cover:

- Defects caused by misuse or poor maintenance. (Please refer to the product instruction booklet for guidance on item use and maintenance).
- Damage caused by improper installation of UPPAbaby parts and/or accessories. (Please refer to product instruction booklet for guidance on item assembly and use).
- Damage caused by corrosion mold or rust due to poor maintenance, service or storage.
- Damage resulting from normal wear and tear.
- Damage or degradation caused by the sun, sweat, detergents, damp storage conditions or frequent washings.
- Repairs or modifications carried out by a third party.
- Product purchased from an unauthorized retailer. (Approved retailers are listed on our website [uppababy.com](http://uppababy.com)).
- Second owners and users other than the registrant.
- Damage resulting from airline shipping and handling.
- Products Involved in an accident.

UPPAbaby reserves the right to determine if warranty terms and conditions have been met.

For warranty service: In the US\* and CA please contact UPPAbaby customer service (844) 823-3132 and visit [uppababy.com/support](http://uppababy.com/support) to send an email.











USA | UPPAbaby, 276 Weymouth Street, Rockland, MA 02370  
uppababy.com | 1.844.823.3132

Model 1002-MSA-US

All rights reserved. © 2024 UPPAbaby. UPPAbaby and all associated logos are trademarks. All product specifications are correct at time of print. UPPAbaby reserves the right to change anything at any time without prior notice. Color representation is as close as print processes allow. Not all colors available at all retailers. UbMAN096-V16