

UPPAbaby®
ALTA™ **V2**



From 40–100 lbs

Product Information	2	Installation and Usage	16
Registration	2	Booster Assembly	16
Certification	2	Active Support Headrest Adjustment	18
Lifetime Warranty	3	SecureFit Lap Belt Positioner	19
Warnings and General Safety Information	4	Install Using Lower Anchors	21
Child Usage Requirements	9	Release from Lower Anchors	23
Vehicle Compatibility	10	Storing Lower Anchors	24
Overview of Vehicle Seat Belt Systems	10	Use Without Lower Anchors	25
Lower Anchors and Tether for CHildren (LATCH)	12	Securing the Child	26
Vehicle Head Restraint	13	Additional Information	28
Product Overview	14	Remove Seat Cover	28
		Remove Headrest Cover	30
		Install Headrest Cover	32
		Install Seat Cover	34
		Cup Holder Use	36
		Cleaning and Maintenance	37
		Warranty	38

**Read all instructions before use
of this Child Restraint.**

Keep these instructions for future reference.

PRODUCT INFORMATION

REGISTRATION

Model Number: _____

Manufactured Date: _____

Expiration Date: _____

CERTIFICATION



This Child Restraint system conforms to all applicable Federal Motor Vehicle Safety Standards (FMVSS).

TAKE A MOMENT TO FILL OUT THE ABOVE INFORMATION found on the manufacture labels or engraved on the underside of the booster.



Child restraints could be recalled for safety reasons. You must register this restraint to be reached in a recall. Send your name, address, email address if available and the restraint's model number and manufacturing date to 276 Weymouth Street, Rockland, MA 02370 or call (844) 823-3132 or register online at: uppababy.com/register/carseat.

For recall information, call the U.S. Government's Vehicle Safety Hotline at 1-888-327-4236 (TTY: 1-800- 424-9153), or go to <http://www.NHTSA.gov>

WELCOME TO THE FAMILY

We are with you for the long haul. Register your car seat within three months to claim your Limited Lifetime Warranty.*

Thank you for being part of the UPPAbaby family.



*Lifetime warranty applies to UPPAbaby car seats and the original owner, within the lifetime of the product. To receive your Limited Lifetime Warranty, you MUST register within three months of purchase and provide a valid purchase receipt from an authorized UPPAbaby retailer. The “lifetime” of the product is defined as the period of use by the registrant for use with his/her children up to 10 years from date of manufacture. For complete UPPAbaby Warranty refer to page 38.

For replacement parts, service or additional questions, please contact our Customer Experience Team:
uppababy.com/support | email: support@uppababy.com | 844-823-3132

WARNING

DEATH OR SERIOUS INJURY CAN OCCUR

According to accident statistics, children are statistically safer when properly restrained in the rear seating positions than in the front seating positions, whether there are airbags, advanced airbags or no airbags at all. To ensure your child's safety refer to approved seating positions on page 11 in this manual or your Vehicle's Owner Manual.

- **NEVER** leave Child Restraint unsecured in your vehicle even when it is unoccupied. In a crash, it could become a projectile and injure other vehicle occupants.
- **DO NOT** use this child restraint without the seat cover. Failure to do this can result in serious injury.
- Use the child restraint only on vehicle seats that face forward.
- **DO NOT** use on seats that face the sides or rear of the vehicle.

WARNINGS + GENERAL SAFETY INFORMATION



NEVER place this child restraint on a front seat with an airbag. **DEATH OR SERIOUS INJURY** can occur. An airbag can strike a rear-facing infant restraint with enough force to crack the shell and seriously injure or kill an infant. The back seat is the safest place for children 12 and under. Refer to the vehicle owner's instruction book before installing this child restraint in a seating position with side airbags.

Failure to follow these instructions could result in serious injury to your child or other vehicle occupants.

- **NEVER** leave child unattended
- **DO NOT** use this child restraint system if it has been in a vehicle accident
- Ensure that the child's head is positioned correctly within the headrest and that the shoulder belt is placed correctly over the child's shoulders.

WARNINGS + GENERAL SAFETY INFORMATION

- **DO NOT** use this Child Restraint system in a vehicle seating position where it cannot be tightly secured.
- **DO NOT** modify this restraint except as instructed in this instruction book. Minor modifications can change the way a Child Restraint performs in a crash.
- **DO NOT** leave loose objects, e.g. cups, toys, bags, umbrellas, etc., in the vehicle because they can become deadly projectiles in a crash.
- **DO NOT** take child out of the Child Restraint while the vehicle is moving.
- **DO NOT** allow children to play with this Child Restraint. It is not a toy.
- **DO NOT** use any accessories, pads, or products supplied by other manufacturers with this Child Restraint, unless approved and tested by UPPAbaby. Items not tested with this restraint could injure your child.
- **DO NOT** remove or cover up any of the warning or product labels on this Child Restraint. All labels include information required by law.

WARNINGS + GENERAL SAFETY INFORMATION

- **ALWAYS** check all surfaces of restraint before securing your child. In warm weather, child restraints can become very hot. Park in the shade or where sun does not directly hit the child restraint. Cover the child restraint with a sheet or blanket when not in use.
- **ALWAYS** properly store lower anchor connectors when not in use.
- Check the vehicle owner's manual for more information about airbag/child restraint use.
- For vehicles without a back seat, refer to your vehicle owner's manual.
- Check the vehicle belt before each use. Use only if the belt is tightened properly and securely.
- **DO NOT** use a child restraint with damaged or missing parts.
- Read all instructions for additional warnings.
- **DO NOT** use only lap belt when using this seat.

WARNINGS + GENERAL SAFETY INFORMATION

- The shoulder belt must always be adjusted snugly across the child's chest.
- **NEVER** place the shoulder belt under the child's arms.
- **NEVER** use this Child Restraint on an aircraft. This Restraint is Not Certified for Use in Aircraft.

CHILD USAGE REQUIREMENTS

This child restraint is for use by children who meet Both requirements below:



WEIGHT REQUIREMENTS: 40–100 lbs (18.1–45.4 kg)

HEIGHT: REQUIREMENTS: 38–57" (96.5–144.8 cm)

- **DO NOT** use this child restraint beyond the expiration date or if the child outgrows either the weight or height requirements.
- This booster is **NOT** for use with children who weigh less than 40 lbs (18.1 kg).
- Use only the vehicle's lap and shoulder belt system when restraining the child in this booster.
- **IMPORTANT:** This product is **NOT** to be used without a backrest, and the backrest should never be separated from the base.

WARNING

DEATH OR SERIOUS INJURY CAN OCCUR

CHECK YOUR VEHICLE INSTRUCTION BOOK for information regarding your vehicle seat belt system(s).
Not all vehicle seat belts work with this Child Restraint.

- Use only the vehicle's lap and shoulder belt system when restraining the child in this booster.
- **DO NOT** use this Child Restraint with the following seat belt systems:

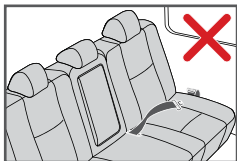

Lap Belt ONLY

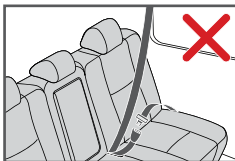

Motorized (Automatic)

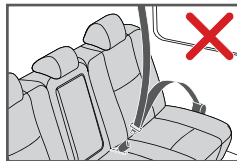

Door Mounted

NOTE: Refer to your vehicle's owner manual for information regarding booster use with vehicle seats that have switchable retractors or inflatable seat belts.

VEHICLE COMPATIBILITY – Overview of Vehicle Seat Belt Systems

PLEASE READ THE FOLLOWING INFORMATION BEFORE INSTALLING THIS CHILD RESTRAINT!

Check Your Vehicle's Owner Manual

Vehicle seat belts differ from vehicle to vehicle. This booster is compatible with most vehicle seat belt systems and can **ONLY** be used with three-point (lap-shoulder) vehicle seat belts.

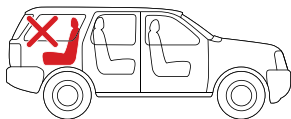
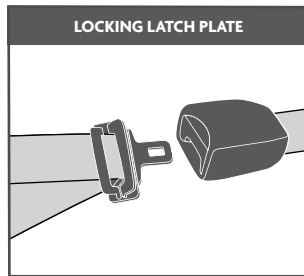
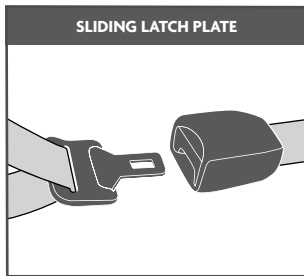
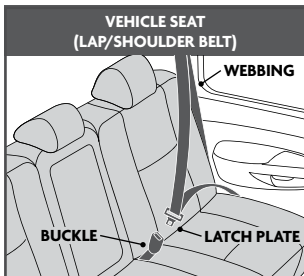

This Child Restraint can only be installed on vehicle seats that face forward.

DO NOT install in seats that face to the sides or rear of the vehicle.

VEHICLE COMPATIBILITY – Lower Anchors and Tether for Children (LATCH)

The lower anchor system helps to anchor the booster seat in the car for stability and to prevent it from becoming a projectile when not occupied in the event of a crash.

This booster can be installed with lap shoulder belts in a vehicle that contains lower anchors. You must use the lap-shoulder belt to properly secure your child. The lower anchors must be standard spacing 11" (28 cm). Check your vehicle's owner manual to determine lower anchor compatible seating positions.

When not in use, the lower anchor connectors must be properly secured in the base of the booster.

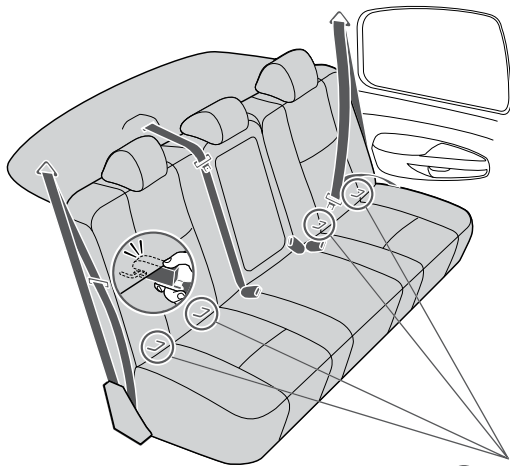

VEHICLE COMPATIBILITY – Vehicle Head Restraint

The back of the booster MUST fit tightly against the back of the vehicle seat, and the front of the booster MUST NOT hang over the front of the vehicle seat. If the vehicle head restraint cannot be adjusted or removed, a different seating position or different booster seat should be used.

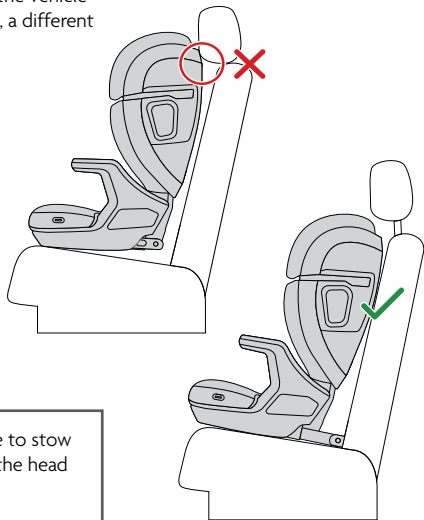
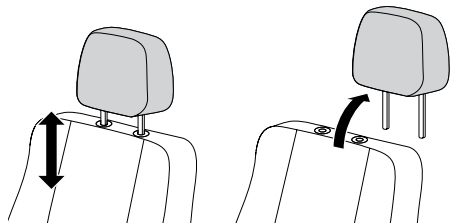

IMPORTANT: If you remove your vehicle head restraint, be sure to stow in a secure place. Check your vehicle's owners manual. Replace the head restraint when the booster is removed from the vehicle seat.

PRODUCT OVERVIEW

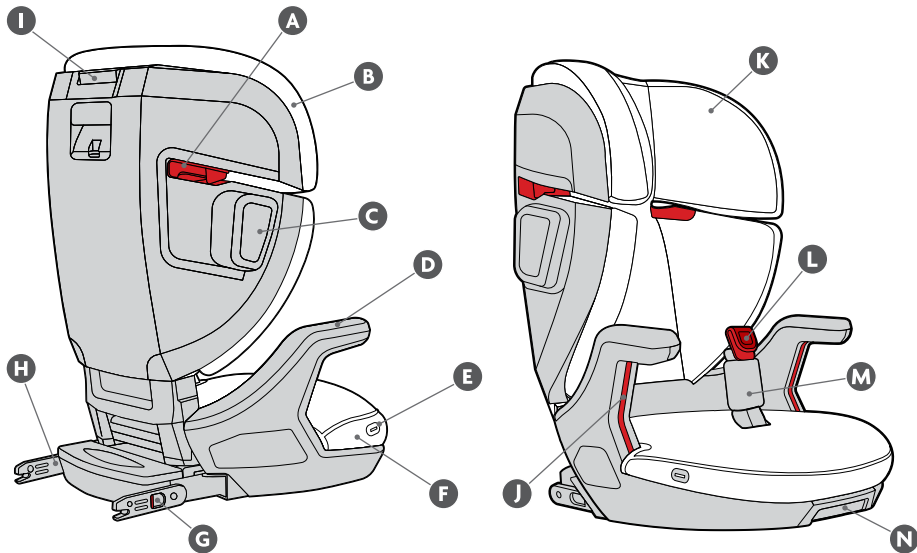

PRODUCT OVERVIEW

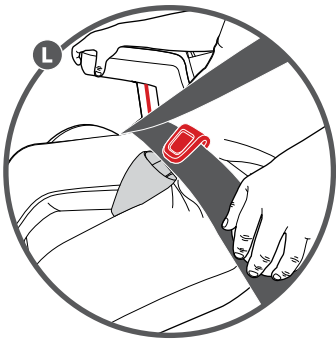

- A** SecureFit Shoulder Belt Guide
- B** Upper Seat Cover
- C** Side Impact Pods
- D** Armrests
- E** Cup Holder Attachment
- F** Lower Seat Cover
- G** Lower Anchor Connector Release/
Red to Green Indicator
- H** Rigid Lower Anchor Connect
- I** Backrest Adjustment Button
- J** SecureFit Lap Belt Guide
- K** Energy Response Headrest
- L** SecureFit Lap Belt Positioner
- M** Lap Belt Positioner Cover
- N** Lower Anchor Release Handle

INSTALLATION AND USAGE – Booster Assembly

IMPORTANT: This product is **NOT** to be used without a backrest, and the backrest should never be separated from the base.

- 1 Lay the Booster Seat Bottom on floor facing up.
- 2 Attach the Backrest to the Booster Seat Bottom, by hooking over the seat bar hinge on the seat bottom as shown.
- 3 Rotate the Backrest up until it clicks into the full upright position and locks into place.
- 4 Tuck the Fabric Panel between the Backrest Fabric Cover and the Seat Back Frame. Be sure Fabric Panel is flat against the Seat Back Frame.

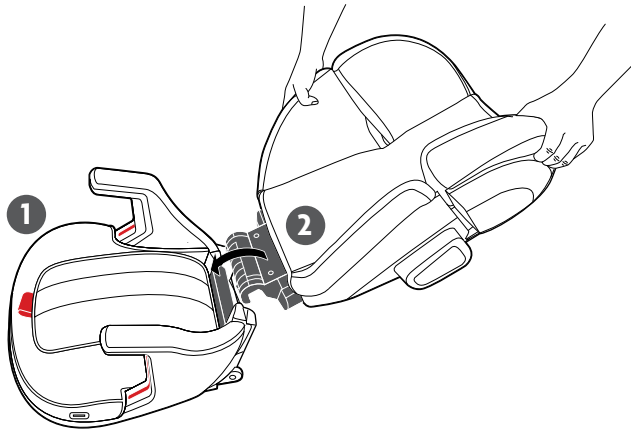

INSTALLATION AND USAGE – Booster Assembly

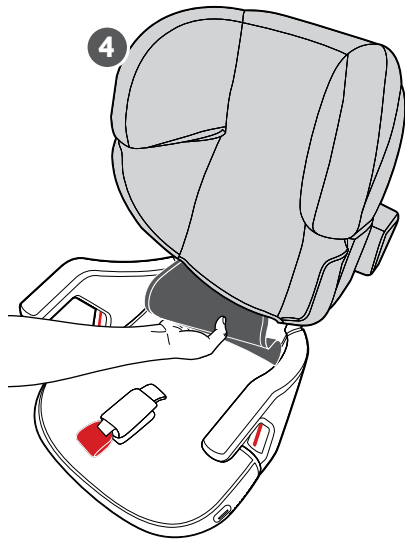
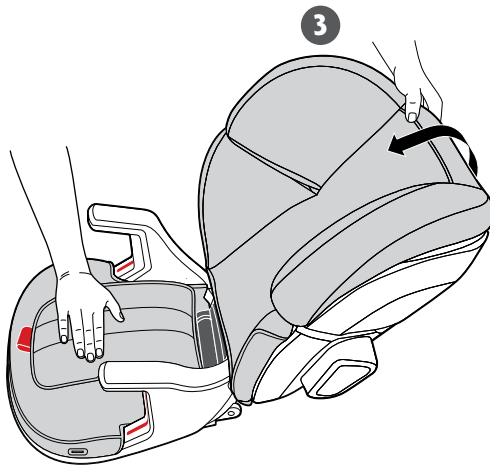

INSTALLATION AND USAGE – Active Support Headrest Adjustment

TO ADJUST THE HEADREST

The Headrest can be adjusted for best fit to your child and optimized protection.

NOTE: The headrest can be adjusted with the child in the seat.

- 1 Squeeze grey button at top of seat.
- 2 Slide headrest to desired height.

PROPER HEADREST HEIGHT

Proper height of the headrest and belt guides are critical for optimal performance. The Headrest should rest just above the top of the child's shoulders ensuring the shoulder belt guide is properly positioned.

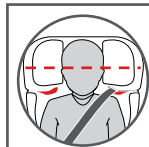

IMPORTANT: The child's ears **MUST** be below the top of the booster headrest.

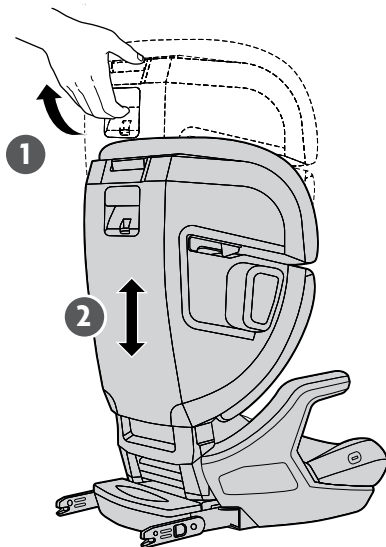

INSTALLATION AND USAGE – SecureFit Lap Belt Positioner

IMPORTANT: The lap portion of the belt should rest on the top of the child's thighs and **NOT** across the child's abdomen.

We strongly recommend using the Lap Belt Positioner. The Lap Belt Positioner holds the lap part of the vehicle belt in place for proper belt positioning.

TO USE THE LAP BELT POSITIONER

Hook the **RED LAP BELT POSITIONER** over the Vehicle Lap Belt as shown.

NOTE: Adjust the Lap Belt Positioner as needed - See the ADJUSTING THE LAP BELT POSITIONER section for more details (page 20).

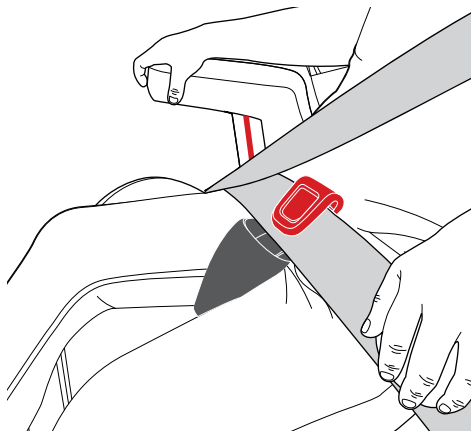

INSTALLATION AND USAGE – SecureFit Lap Belt Positioner

TO ADJUST THE LAP BELT POSITIONER

NOTE: You may have to open the Lap Belt Positioner Soft Cover to access the Lap Belt Positioner and strap.

- 1 Pull down on the strap to tighten.
- 2 Pull up on the bottom of the Lap Belt Positioner to loosen.
- 3 Adjust the Lap Belt Positioner so that the vehicle lap belt lies flat and snug across the child's upper thighs and not above.

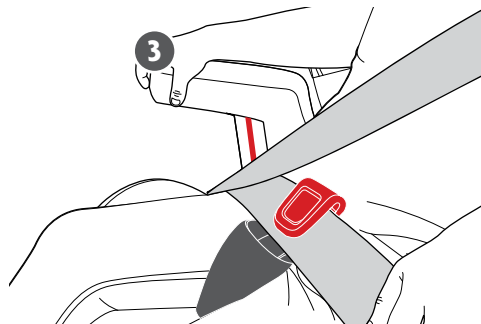
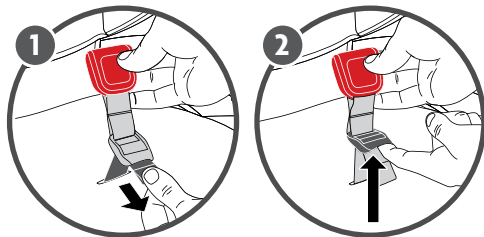

IMPORTANT: The lap portion of the vehicle belt **MUST NOT** rest on the child's abdomen.

INSTALLATION AND USAGE – Install Using Lower Anchors

Lower Anchors can be used to prevent the booster from becoming a projectile in the car when not in use. The Lower Anchor system does not restrain your child. You must use the lap-shoulder belt to properly secure your child. Always refer to your vehicle's owner manual to determine if your vehicle is equipped with Lower Anchors and in what seating positions.

TO INSTALL USING LOWER ANCHORS

- 1 To release the Rigid Lower Anchors Connectors, pull the Lower Anchors Release handle located at the front of the seat to expose from the storage housing.
- 2 Rotate the Rigid Lower Anchors Connectors 180-degrees until they are pointing toward the Lower Anchors in the vehicle.

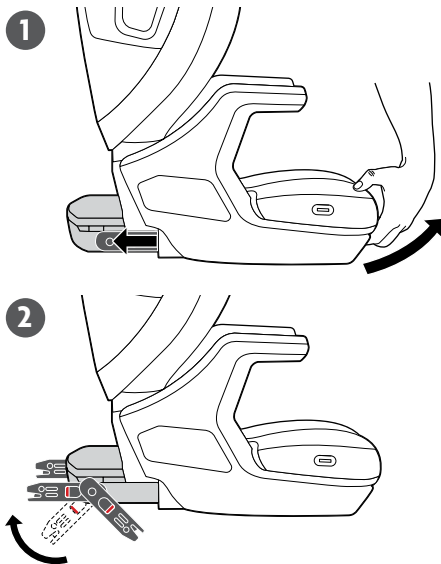

INSTALLATION AND USAGE – Install Using Lower Anchors

NOTE: Before installing the booster, pull the Rigid Lower Anchor Connectors to ensure they are fully extended from the housing.

- 3 Place the booster on the vehicle seat. Push the Rigid Lower Anchor Connectors onto BOTH Lower Anchors until you hear a click. The red to green indicators located on connectors should be green indicating a secure connection. Pull back on each connector to ensure secure.
- 4 Pull Lower Anchor Release Handle and push the booster in the seat tight until the backrest sits against the vehicle seat back.

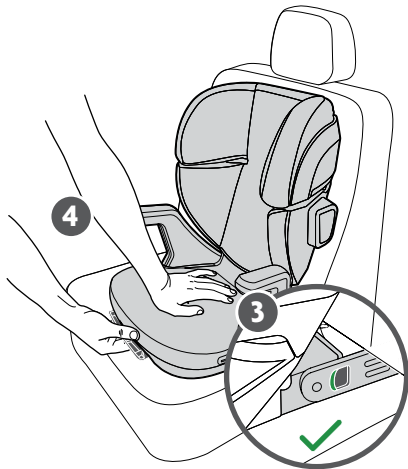

The back of the booster **MUST** fit tightly against the back of the vehicle seat, and the front of the booster **MUST NOT** hang over the front of the vehicle seat. If the vehicle head restraint cannot be adjusted or removed, a different seating position or different booster seat should be used.



The Rigid Lower Anchor Connector indicators will both show **GREEN** when properly secured.

INSTALLATION AND USAGE – Release from Lower Anchors

TO RELEASE FROM LOWER ANCHORS

To release the booster from the Lower Anchors pull back on the Lower Anchor Connector Release located on the side of each Rigid Lower Anchor Connector and remove the booster from the vehicle seat.

IMPORTANT: NEVER leave Child Restraint unsecured in your vehicle even when it is unoccupied. In a crash, it could become a projectile and injure other vehicle occupants.

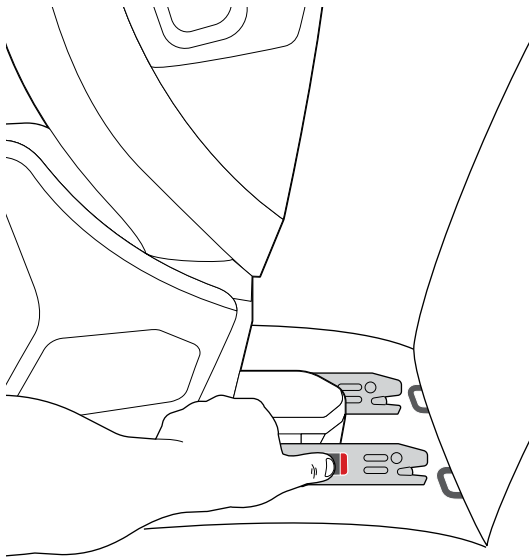

INSTALLATION AND USAGE – Storing Lower Anchors

TO STORE RIGID LOWER ANCHOR CONNECTORS

- 1 Rotate both Rigid Lower Anchor Connectors back towards seat.
- 2 While pulling the Lower Anchor Release at the front of booster, simultaneously push the Lower Anchor Housing back towards the booster until it locks into place.

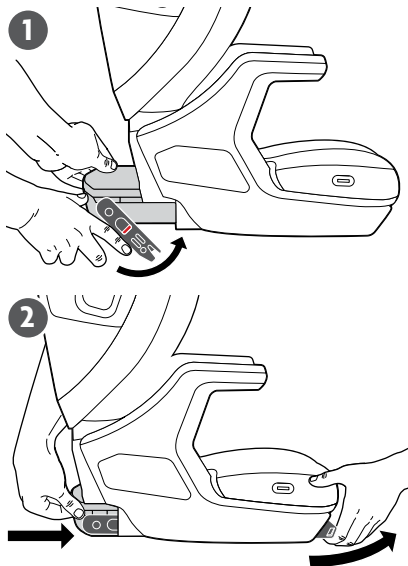

IMPORTANT: ALWAYS properly store Rigid Lower Anchor Connectors when not in use.

INSTALLATION AND USAGE – Use Without Lower Anchors

TO INSTALL WITHOUT USING LOWER ANCHORS

With Rigid Lower Anchor Connectors stored, place the booster on the vehicle seat with the backrest flush with the vehicle seat back.

IMPORTANT: NEVER leave Child Restraint unsecured in your vehicle even when it is unoccupied. In a crash, it could become a projectile and injure other vehicle occupants. When not using Lower Anchor, use the vehicle lap and shoulder belt to secure the booster.



The back of the booster **MUST** fit tightly against the back of the vehicle seat, and the front of the booster **MUST NOT** hang over the front of the vehicle seat. If the vehicle head restraint cannot be adjusted or removed, a different seating position or different booster seat should be used.

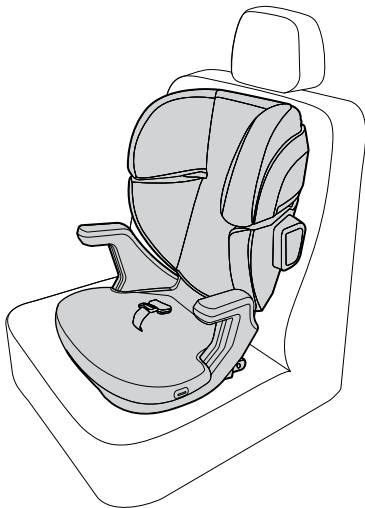

INSTALLATION AND USAGE – Securing the Child

TO SECURE THE CHILD IN THE BOOSTER

- 1 With the booster correctly positioned in the vehicle and the Headrest in the proper position, route the Vehicle Shoulder Belt across the child's chest and through the **RED LOWER BELT PATH A**, **UNDER** the armrest towards the Vehicle Buckle.
- 2 Buckle the Vehicle Belt.
- 3 Slide the Vehicle Shoulder Belt into the **RED SHOULDER BELT GUIDE B** ensuring it passes completely under the Shoulder Belt Guide hook and does not fall off the child's shoulder. Remove slack from vehicle seat belt.
- 4 The Vehicle Lap Belt must lie flat and snug across the child's upper thighs. We strongly recommend using the Lap Belt Positioner. Adjust the **RED LAP BELT POSITIONER C** such that when you route the lap belt under it, the lap belt sits flat across the child's upper thighs and not above.

NOTE: Refer to page 19 for LAP BELT POSITIONER installation and instruction.

IMPORTANT: The lap and shoulder belt must route under the armrest on the buckle side.

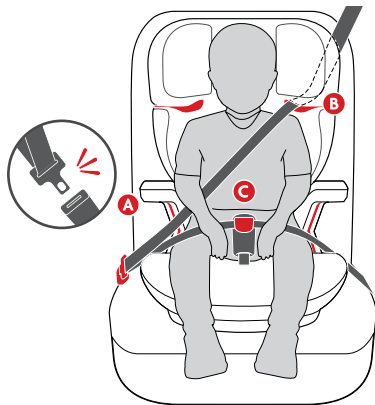

IMPORTANT: The child's ears **MUST** be below the top of the booster headrest.

INSTALLATION AND USAGE – Securing the Child

TO REMOVE VEHICLE SEAT BELT

- 1 Grasp vehicle belt near the **RED SHOULDER BELT GUIDE** while holding lever up with the opposite hand.
- 2 Continue to pull out vehicle belt until it is released from the **RED SHOULDER BELT GUIDE**.

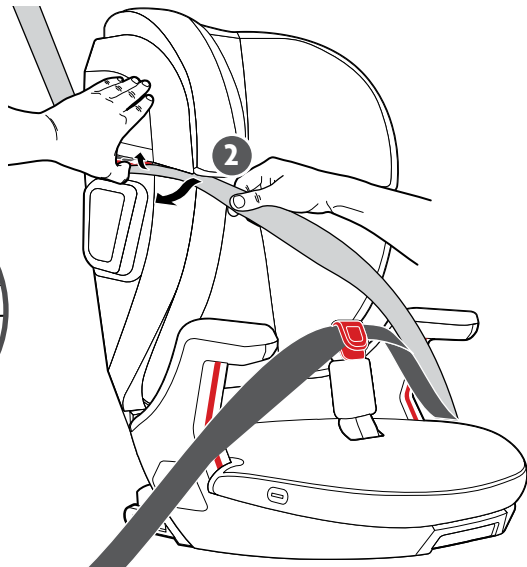
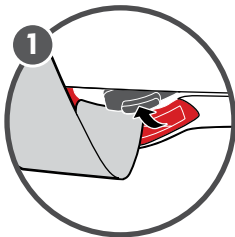

Remove Seat Cover

The Seat Cover can be removed for cleaning. See the **CLEANING AND MAINTENANCE** section (page 37) for more details.

TO REMOVE THE SEAT COVER

- 1 Release elastic from both sides of the seat bottom at the **RED VEHICLE BELT GUIDE**.
- 2 Pull to release both snap buttons at the back of the seat cover and pull the back of the seat cover out from behind the headrest.

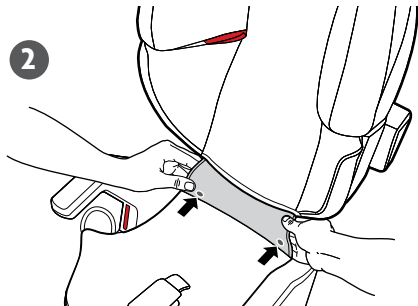

Remove Seat Cover

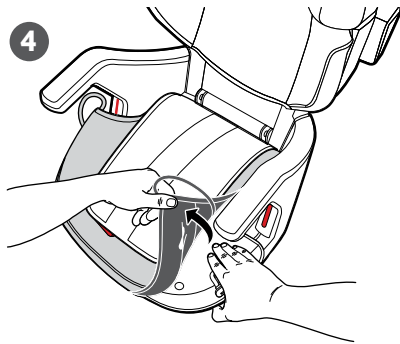
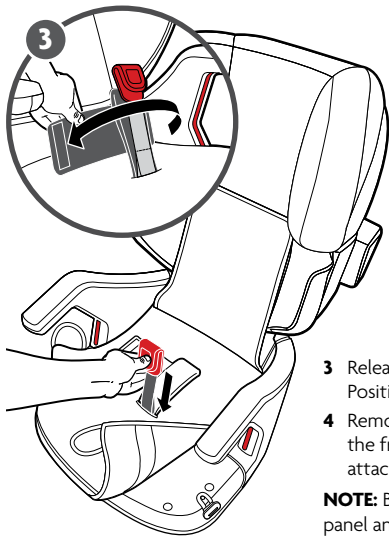

- 3 Release closure from around Lap Belt Positioner Cover and pull Lap Belt Positioner under fabric.
- 4 Remove seat cover at seat bottom by removing the fabric towards the front of the seat and releasing the fabric from the side cup holder attachment.

NOTE: Before washing the seat cover, remove the fabric tool from the back panel and place it in a safe location (refer to page 32 for location). The fabric tool will be required when reinstalling your seat cover onto the Booster.

Remove Headrest Cover

The Headrest Cover can be removed for cleaning. See the **CLEANING AND MAINTENANCE** section (page 37) for more details.

TO REMOVE THE HEADREST COVER

- 1** Pull on the lower edge of the Headrest Cover to remove the fabric from the slot that runs around the outside of the Booster. Continue up the side of the booster, pulling the fabric away from the side bolsters and **RED SHOULDER BELT GUIDE**. Repeat for the other side.
- 2** From behind, pull the fabric tab out of the slot in the top of the Booster.
- 3** Continue to pull the top of the Headrest Cover fabric down to release the elastic straps from both of the plastic hooks in the Booster.

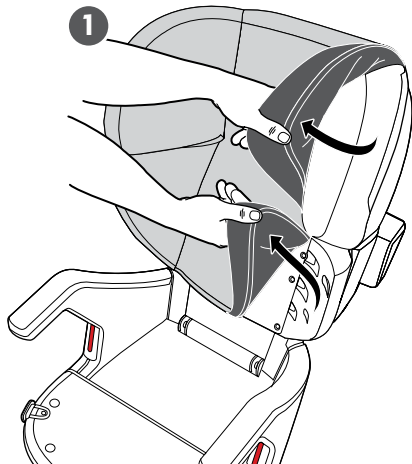

Remove Headrest Cover

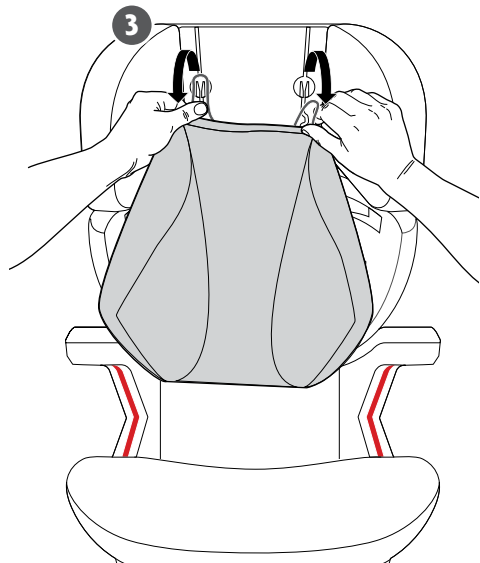
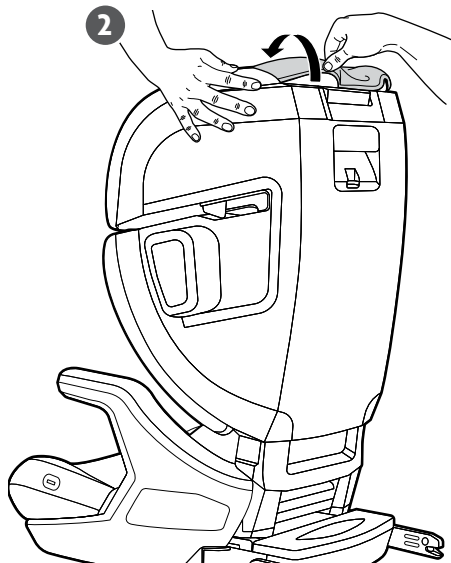

Install Headrest Cover

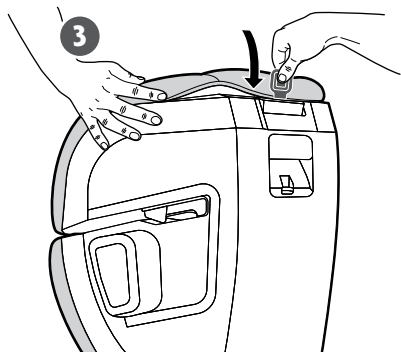
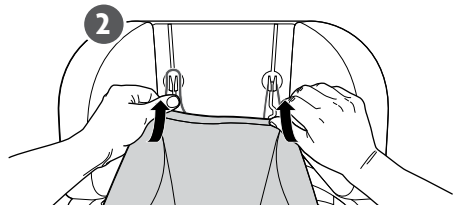
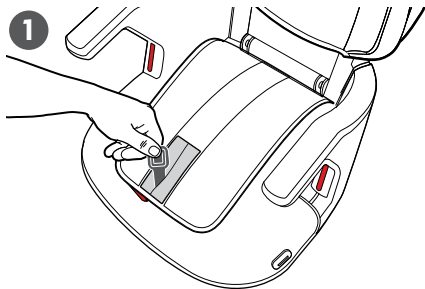

TO INSTALL THE HEADREST

- 1 Locate the fabric tool prior to installation.
- 2 Hook the elastic straps on the Headrest Cover around both of the plastic hooks located at the top of the Booster seat back. Pull both elastic straps up and through the cutouts in the foam.
- 3 Use the fabric tool to push the top of the Headrest Cover into the slot at the top of the Booster.

Install Headrest Cover

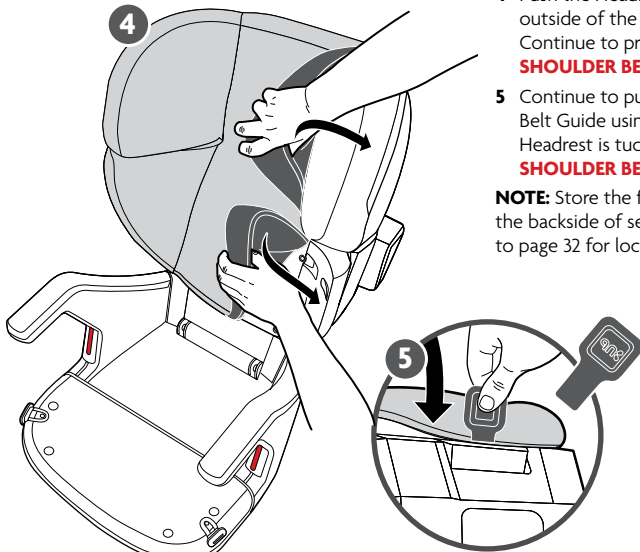

- 4 Push the Headrest Cover into the slot on the outside of the side bolster using the fabric tool. Continue to press the fabric into slot under the **RED SHOULDER BELT GUIDE**. Repeat for the other side.
- 5 Continue to push the Headrest behind the Shoulder Belt Guide using the fabric tool. Check that the Headrest is tucked completely outside of the **RED SHOULDER BELT GUIDE**. Repeat on the other side.

NOTE: Store the fabric tool in designated pocket on the backside of seat fabric panel when not in use (refer to page 32 for location).

Install Seat Cover

TO INSTALL THE SEAT COVER

- 1** Pull the Lap Belt Positioner through the opening in the fabric, located in front of the elastic webbing on the underside of the fabric. Continue to pull it through the Lap Belt Positioner Cover, wrap the cover around it, and secure with the closure.
- 2** Insert back panel of seat cover under the headrest fabric and attach snap on both sides of fabric to the seat.
- 3** Attach elastic to both sides of seat bottom fabric at **RED VEHICLE BELT GUIDE**.
- 4** Tuck fabric around cup holder attachment and around seat.

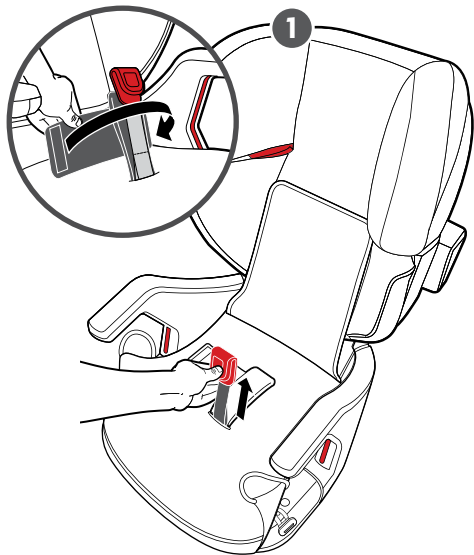

Install Seat Cover

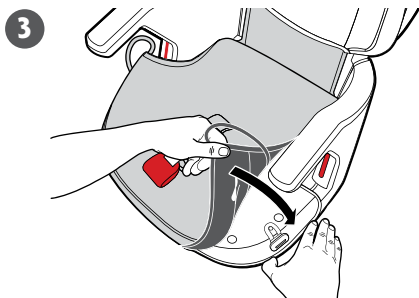
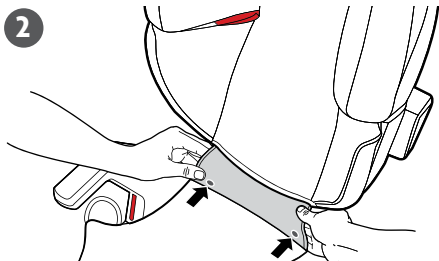

Cup Holder Use

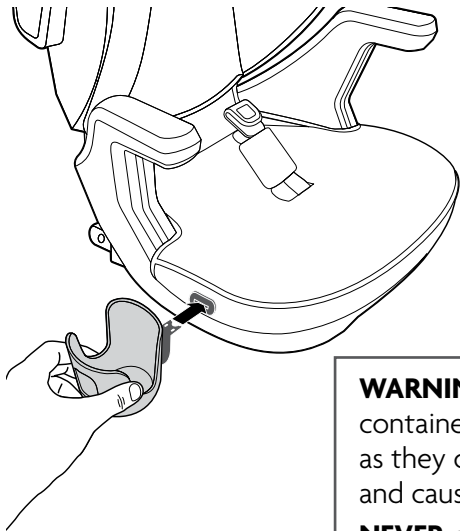

TO ATTACH THE CUP HOLDER

Push cup holder at a higher angle pushing firmly down until it clicks into place.

TO REMOVE THE CUP HOLDER

Pull down firmly and then pull out.

NOTE: Cup holder can be installed on either side of booster.

WARNING: DO NOT place glass, metal containers or hard sharp objects in cup holder as they could become a projectile in a crash and cause serious injury.

NEVER put a hot liquid in the cup holder.

CLEANING AND MAINTENANCE

CLEANING FABRICS - Fabrics include: seat, headrest and lap belt positioner cover



Machine wash in cold water on gentle cycle with mild detergent. **DO NOT** bleach.



Dry flat and away from direct sunlight before re-use or storage.



DO NOT iron or dry clean.

CLEANING LAP BELT POSITIONER WEBBING



Spot clean using warm water with mild detergent. **DO NOT** bleach.



Air dry completely before re-use or storage.

CLEANING PLASTIC



Spot clean using warm water with mild detergent.



Towel dry completely before re-use or storage.

CLEANING LOWER ANCHOR CONNECTORS - Anchors should fasten with a “click”. If not, rinse under warm running water. **DO NOT** use detergents or lubricants.

WARRANTY



Welcome to the UPPAbaby family! We are with you for the long haul. Register your car seat within three months to claim your Limited Lifetime Warranty*.

Register your product at: uppababy.com/register/carseat

*Lifetime warranty applies to UPPAbaby car seats and only the original owner, within the lifetime of the product. To receive your Limited Lifetime Warranty, you **MUST** register your car seat within three months of purchase and provide a valid purchase receipt from an authorized UPPAbaby retailer. The “lifetime” of the product is defined as the period of use by the registrant for use with his/her children up to 10 years from date of manufacture.

Your UPPAbaby product is warranted to be free from any manufacturing defects for a period of 2 years from the date of purchase under normal use and in compliance with the operating instructions.

This warranty is not transferable and extends only to the original retail purchaser and is only valid when supplied with proof of purchase from an authorized retailer. Proof of purchase must be retained for this warranty.

The warranty is valid only in the original country of purchase. This warranty is subject to the conditions set forth by country in which the items were purchased. Conditions may vary. UPPAbaby will not ship replacement or repair parts out of the country of purchase.

UPPAbaby will provide replacement parts or conduct repairs as determined fitting by the company. UPPAbaby reserves the right to exchange item with a replacement part. Some parts may be replaced with newer model parts as the product is improved over time.

WARRANTY

This warranty does not cover:

- Defects caused by misuse or poor maintenance. (Please refer to the product instruction manual for guidance on item use and maintenance).
- Damage caused by improper installation of UPPAbaby parts and/or accessories. (Please refer to product instruction booklet for guidance on item assembly and use).
- Damage caused by corrosion mold or rust due to poor maintenance, service or storage.
- Damage resulting from normal wear and tear.
- Damage or degradation caused by the sun, sweat, detergents, damp storage conditions or frequent washings.
- Repairs or modifications carried out by a third party.
- Product purchased from an unauthorized retailer. (Approved retailers are listed on our website uppababy.com).
- Second owners and users other than the registrant.
- Damage resulting from airline shipping and handling.
- Products Involved in an accident.

UPPAbaby reserves the right to determine if warranty terms and conditions have been met.

For warranty service: In the US and CA please contact UPPAbaby customer service (844) 823-3132 and visit uppababy.com/support to send an email.



USA | UPPAbaby, 276 Weymouth Street, Rockland, MA 02370
uppababy.com | 1.844.823.3132

Model 1302-ALT-US

All rights reserved. © 2023 UPPAbaby. UPPAbaby and all associated logos are trademarks. All product specifications are correct at time of print. UPPAbaby reserves the right to change anything at any time without prior notice. Color representation is as close as print processes allow. Not all colors available at all retailers. UbMAN171-V02