

UPPAbaby
MESA[®] MAX

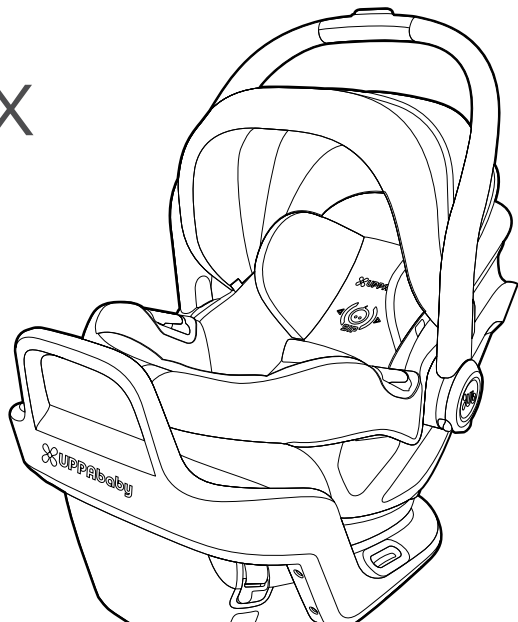

From 4-35 lbs

WELCOME TO THE FAMILY

We are with you for the long haul. Register your car seat within three months to claim your Limited Lifetime Warranty.*

Thank you for being part of the UPPAbaby family.



*Lifetime warranty applies to UPPAbaby car seats and the original owner, within the lifetime of the product. To receive your Limited Lifetime Warranty, you MUST register within three months of purchase and provide a valid purchase receipt from an authorized UPPAbaby retailer. The "lifetime" of the product is defined as the period of use by the registrant for use with his/her children up to 7 years from date of manufacture. For complete UPPAbaby Warranty refer to page 71.

For replacement parts, service or additional questions, please contact our Customer Experience Team:
uppababy.com/support | email: support@uppababy.com | 844-823-3132

Before You Begin	4	Base Installation With Lower Anchors	24
Registration	4	Leveling Base	24
Certification	4	Base Installation With Lower Anchors	25
Child Use Recommendations	5	Installing Load Leg	26
Notice of Expiration	6	What is a Waterfall?	27
		Safety Check	28
Warnings + General Safety Instructions	7	Uninstalling Base	30
Features Overview	14	Storing Load Leg	31
Overview of Base	14		
Overview of Carrier	16	Base Installation With Vehicle Seat Belt	32
		Leveling Base	32
Vehicle Compatibility	18	Lap/Shoulder Routing Method	34
Choosing A Vehicle Seating Location	18	Lap Belt Only Routing Method	36
Determining Best Installation Method	19	Installing Load Leg	38
LATCH (Lower Anchors and Tethers for Children)	20	What is a Waterfall?	39
Overview of Vehicle Seat Belt Systems	21	Safety Check	40
Unsafe Vehicle Seat Belt Systems + Seating	22	Uninstalling Base and Storing Load Leg	42

Carrier Installation with Vehicle Seat Belt	43	Stroller Compatibility	62
Determining Best Installation Method	43	Fitting Carrier to Stroller Frame	62
Leveling the Carrier	44	Releasing Carrier from Stroller Frame	63
Lap/Shoulder Belt Preferred Routing Method	45		
Lap/Shoulder Belt Optional Routing Method	48	Care + Maintenance	64
Lap Belt Only Routing Method	50	SIP Padding Removal	64
Safety Check	51	Seat Padding Removal	65
Aircraft Installation	52	Seat Padding Installation	67
		SIP Padding Installation	69
		Cleaning	70
General Use	53	Warranty	71
Infant Insert	53		
SIP Carriage + Harness Positioning	54		
Securing Your Child	55		
Attaching Carrier to Base	57		
Removing Carrier from Base	58		
Using Canopy	59		
Using Carry Handle	60		
Safety Check	61		

**Read all instructions before use
of this Child Restraint.
Keep these instructions for future reference.**

BEFORE YOU BEGIN

REGISTRATION

Model Number: _____

Manufactured Date: _____

Expiration Date: _____

TAKE A MOMENT TO FILL OUT THE ABOVE INFORMATION.

Information can be found on the manufacture labels or engraved on the underside of the carrier.



Child restraints can be recalled for a variety of safety reasons. You **MUST** register this restraint to be reached in a recall. Provide your name, address, email address if available and the restraint's model number and manufacturing date to 276 Weymouth Street, Rockland, MA 02370 or call (844) 823-3132 or register online at: uppababy.com/register/carseat. For recall information, call the U.S. Government's Vehicle Safety Hotline at 1-888-327-4236 (TTY: 1-800-424-9153), or go online to <https://www.NHTSA.gov>.

CERTIFICATION



This Child Restraint system conforms to all applicable Federal Motor Vehicle Safety Standards (FMVSS).



This Child Restraint is certified for aircraft use. UPPAbaby and the Federal Aviation Administration (FAA) strongly urge you to secure your child in a Child Restraint system (CRS) or device for the duration of your flight. This product is designed and manufactured to comply with ASTM 2050 Standard Consumer Safety Specification for Hand Held Carriers.

BEFORE YOU BEGIN

CHILD USE RECOMMENDATIONS

Children should remain rear-facing for as long as possible.

UPPAbaby advises that all infants and toddlers should ride in a rear-facing car safety seat (CSS) as long as possible, until they reach the highest weight or height allowed by their CSS's manufacturer. This child restraint is for use by children who meet BOTH requirements below:

WEIGHT REQUIREMENTS: 4 – 35 lbs (1.8 – 15.9 kg)

HEIGHT REQUIREMENTS: 32 in (81.3 cm) or less

The Infant Insert is designed for children who weigh: **4 – 11 lbs (1.8 – 5 kg)**

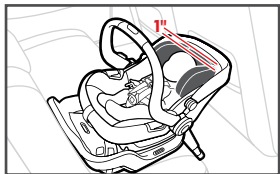

The top of the child's head should not be less than 1" from the top of the headrest when in its highest position.

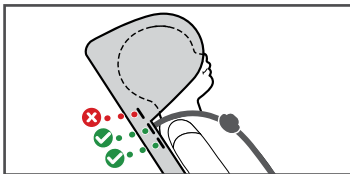

Harness should be at the shoulders or slightly below.

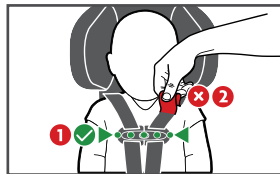

Retainer clip must be at armpit level **1** and harness straps should be snug **2**.

BEFORE YOU BEGIN

NOTICE OF EXPIRATION

Discontinue use of this child restraint after 7 years from the date of manufacture or after a crash. Refer to labels on bottom of Carrier and Base.

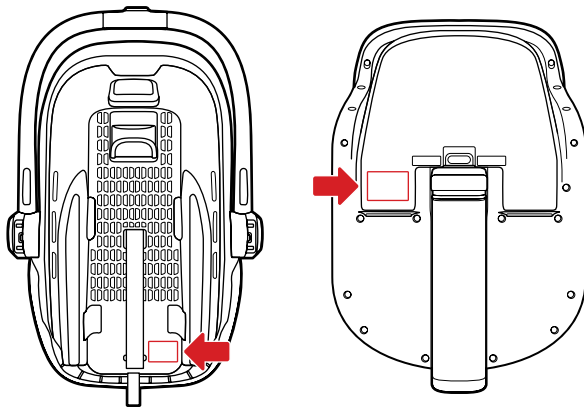

WARNINGS + GENERAL SAFETY INFORMATION

WARNING

DEATH OR SERIOUS INJURY CAN OCCUR

According to accident statistics, children are safer when properly restrained in the rear seating positions than in the front seating positions. **NEVER** leave Child Restraint unsecured in your vehicle even when it is unoccupied. In a crash, it could become a projectile and injure other vehicle occupants.



NEVER place this Child Restraint on a front seat with an airbag. **DEATH OR SERIOUS INJURY** can occur. An airbag can strike a rear-facing infant restraint with enough force to crack the shell and seriously injure or kill an infant. The back seat is the safest place for children 12 and under. Refer to the vehicle owner's instruction manual before installing this Child Restraint in a seating position with side airbags.

WARNINGS + GENERAL SAFETY INFORMATION

Snugly adjust the belts provided with this child restraint around your child. A snug strap should not allow any slack. It lies in a relatively straight line without sagging. It does not press on the child's flesh or push the child's body into an unnatural position.

SUFFOCATION HAZARD: Infant carrier can roll over on soft surfaces and suffocate child. **NEVER** place carrier on beds, sofas, or other soft surfaces

WARNING

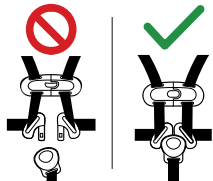

Children have **STRANGLED** in loose or partially buckled harness straps. Fully restrain the child in the seat at all times. **DO NOT** put a child in the seat outside of the vehicle.

WARNINGS + GENERAL SAFETY INFORMATION

- **NEVER** leave child in carrier when straps are loose or undone.
 - **NEVER** place carrier near window where cords from blinds or drapes can strangle a child.
 - **NEVER** hang strings on or over the carrier or attach to handle.
- FALL HAZARD:** Child's movement can slide carrier.
- **NEVER** place carrier on counter tops, tables, or any other elevated surfaces.
DO NOT use on shopping carts.

WARNINGS + GENERAL SAFETY INFORMATION

WARNING



FALL HAZARD: The carrier can fall from the shopping cart.
DO NOT use on shopping cart.

SAFETY WARNINGS

Failure to follow these instructions could result in serious injury to your child or other vehicle occupants.

- **NEVER** leave child unattended.
- **ALWAYS** keep child properly harnessed when child is in carrier.
- **NEVER** leave child in Child Restraint when straps are loose or undone.

WARNINGS + GENERAL SAFETY INFORMATION

- **DO NOT** remove or cover up any of the warning or product labels on this Child Restraint. All labels include information required by law.
- **DO NOT** lubricate buckles and fasteners.
- **ALWAYS** check all surfaces of restraint before securing your child. In warm weather, Child Restraints can become very hot. Park in the shade or where sun does not directly hit the Child Restraint. Cover the Child Restraint with a sheet or blanket when not in use.
- **ALWAYS** properly store lower anchor connectors when not in use.
- Check the vehicle owner's instruction manual for more information about airbag/child restraint use.
- **DO NOT** use seat if damaged or broken, expired (over 7 years from date of manufacture), missing instructions, missing parts, or if the straps are cut, frayed, or damaged in any way.

WARNINGS + GENERAL SAFETY INFORMATION

- **DO NOT** use this Child Restraint system if it has been in a vehicle accident.
- **DO NOT** use clothing or blankets that interfere with fastening or tightening the harness INSTEAD place a blanket over the child after being properly secured in the harness.
- **DO NOT** use this Child Restraint system if the top of the child's head is less than 1" from the top of the headrest when in its highest position.
- **DO NOT** use this Child Restraint system in a vehicle seating position where it cannot be tightly secured.
- **DO NOT** install in rear-facing or side-facing vehicle seats.
- **DO NOT** modify this restraint except as instructed in this instruction manual. Minor modifications can change the way a Child Restraint performs in a crash.
- **DO NOT** leave loose objects, e.g. cups, toys, bags, umbrellas, etc., in the vehicle because they can become deadly projectiles in a crash.

WARNINGS + GENERAL SAFETY INFORMATION

- **DO NOT** take child out of the Child Restraint while the vehicle is moving.
- **DO NOT** allow children to play with this Child Restraint. It is not a toy.
- **DO NOT** use any accessories, pads, or products supplied by other manufacturers with this Child Restraint, unless approved and tested by UPPAbaby. Items not tested with this restraint could injure your child.
- **DO NOT** use a Child Restraint with damaged or missing parts.
- **DO NOT** carry by the canopy.
- **DO NOT** place carrier on top of shopping cart. Carrier will not be secure and could fall causing injury to child.
- **DO NOT** hang objects from Rear Vehicle Seat Belt Guide.
- Properly store lower anchor connectors when not in use.

FEATURES OVERVIEW – Overview of Base

- 1 Vehicle Belt Path (2)
- 2 Lower Anchor Connector Release Buttons (2)
- 3 Anti-Rebound+ Panel
- 4 Tightness Indicator
- 5 Lower Anchor Connectors
- 6 Lower Anchor Connector Webbing
- 7 Vehicle Belt Lock-Off (Closed)
- 8 Level Adjust Handle
- 9 Instruction Manual Storage
- 10 Vehicle Belt Lock-Off (Open)
- 11 Load Leg Angle Indicator
- 12 Load Leg Tension Indicator
- 13 Load Leg Extension Release Button
- 14 Level Angle Indicators (2)
- 15 Level Adjustment Foot
- 16 Lower Anchor Connector Storage
- 17 Load Leg Release Button

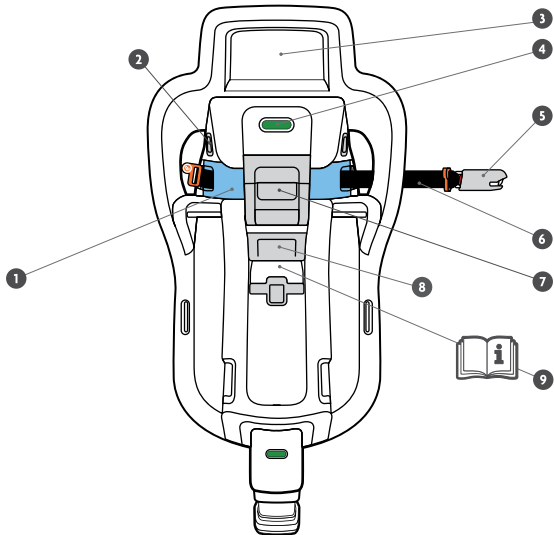

FEATURES OVERVIEW – Overview of Base

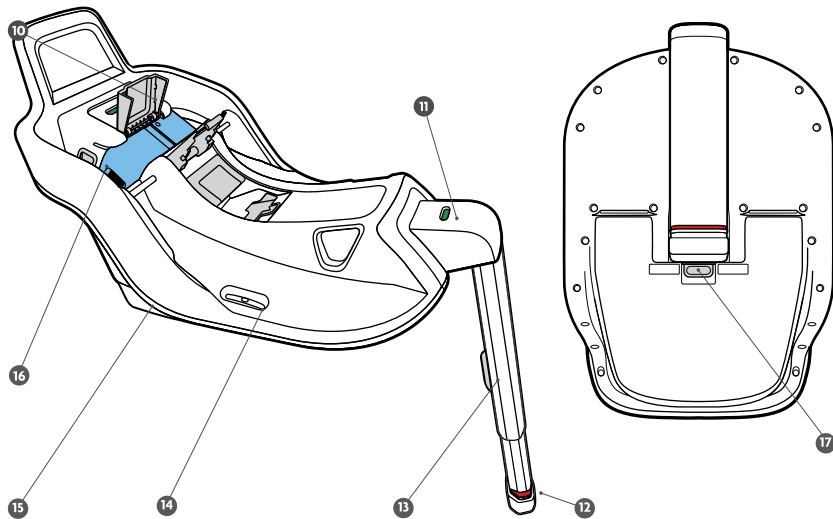

FEATURES OVERVIEW – Overview of Carrier

- 1 Side Impact Protection (SIP)
- 2 Harness Covers (2)
- 3 Buckle
- 4 Infant Insert
- 5 Harness Adjuster Release
- 6 Harness Adjuster Strap
- 7 Buckle Latch Plates (2)
- 8 Vehicle Seat Belt Guides (2)
- 9 Retainer Clip
- 10 Harness Straps
- 11 Canopy
- 12 Carrier Release From Base
- 13 Carrier Release From Stroller
- 14 Carry Handle Adjustment Buttons (2)
- 15 Stroller Attachment
- 16 European Vehicle Belt Guide

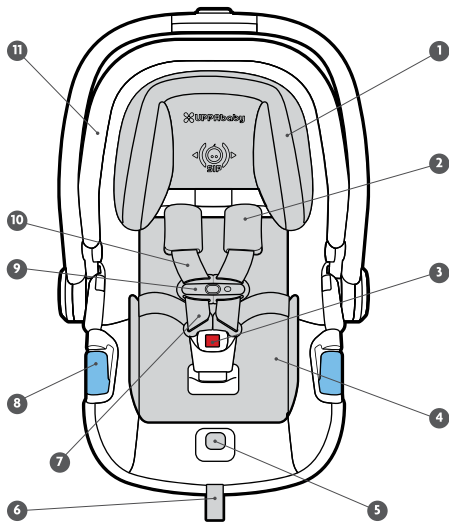

FEATURES OVERVIEW – Overview of Carrier

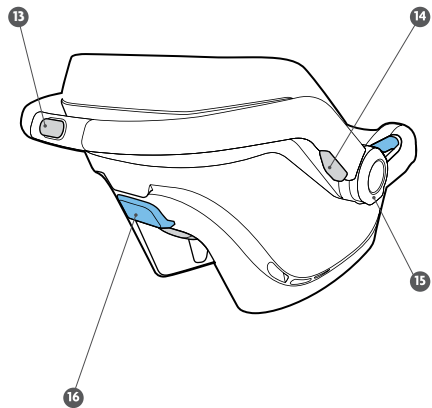
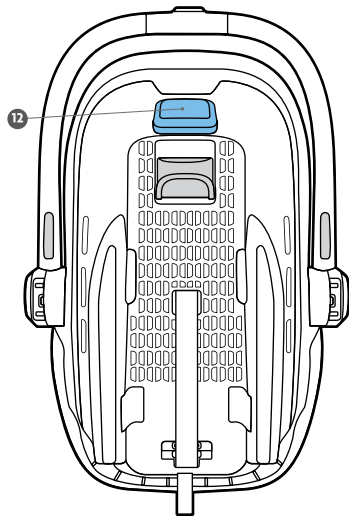

VEHICLE COMPATIBILITY – Choosing a Vehicle Seating Location

Please read the following information before installing this Child Restraint!

The safest seating position is one that works best for your specific car seat, family and vehicle. When determining whether the MESA MAX rear-facing car seat can be used with lower anchors in the rear center seating position, it is critical that you refer to your vehicle owner's instruction book. If the MESA MAX does not install best in the rear center seating location, it is recommended to move to one of the outboard seating positions.

Before installing this child restraint you **MUST** determine the method of installation and the best vehicle seating position for that method. This child restraint can be installed either using **LATCH** or the **VEHICLE SEAT BELT**.

ALWAYS park on a level surface when installing a Child Restraint.

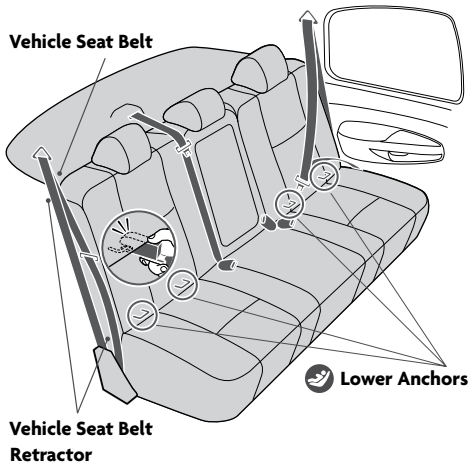
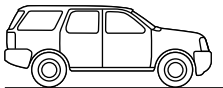

VEHICLE COMPATIBILITY – Determining Best Installation Method

At this point take out your Vehicle owner's instruction manual. You will need this to look up different features in your vehicle that might affect the installation.

WARNING! NEVER place a rear-facing only child restraint in front of an active airbag.

BASE INSTALLATION

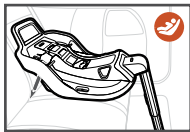

Lower Anchor
(pg 24)

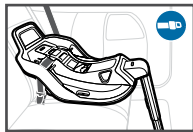

Lap/Shoulder Belt
(pg 32)

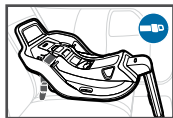

Lap Belt Only (pg 32)

CARRIER INSTALLATION

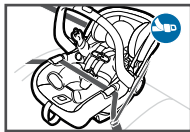

**Lap/Shoulder Belt
Preferred Routing**
(pg 44)

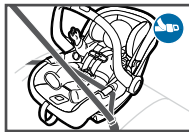

**Lap/Shoulder Belt
Optional Routing**
(pg 44)



Lap Belt Only
(pg 44)



NOTE: The carry handle must be locked in the (4th) rebound position when in use.



VEHICLE COMPATIBILITY

LATCH (Lower Anchors and Tethers for Children)

Most vehicles manufactured after September 1, 2002 are equipped with **LATCH (Lower Anchors and Tethers for Children)**. Check your vehicle owner's instruction book to determine lower anchor compatible seating positions.

NOTE: No tether is required with this rear-facing carrier. Only lower anchors are used.

NOTE: In order to use the rear center seating position with lower anchor, the distance between the lower anchors may be up to 22" and the seating position must be approved by the vehicle manufacturer. If spacing between the lower anchors is greater than 22" or if the seating position is not approved by the vehicle manufacturer then use the vehicle seat belt for installation.

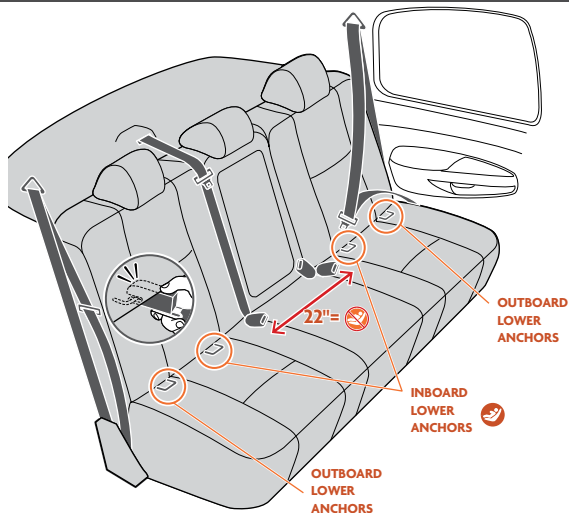

VEHICLE COMPATIBILITY

Overview of Vehicle Seat Belt Systems



If you do not use lower anchor to properly secure the child restraint you must use the **VEHICLE SEAT BELT SYSTEM**. Seat belt systems vary by make, model, and year of your vehicle. There are some vehicle belts that will NOT work with this child restraint or that require additional steps.

CHECK YOUR VEHICLE OWNER'S INSTRUCTION BOOK for information regarding your vehicle seat belt system(s).

This child restraint is compatible with most vehicle seat belt systems.

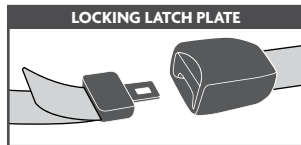
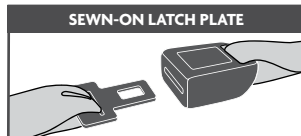
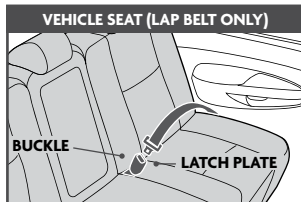
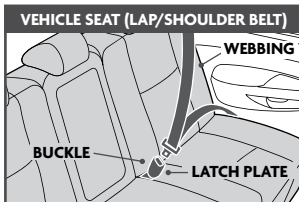

VEHICLE COMPATIBILITY – Unsafe Vehicle Seat Belt Systems + Seating

This Child Restraint can only be installed on vehicle seats that face forward.

DO NOT install in seats that face to the sides or rear of the vehicle.

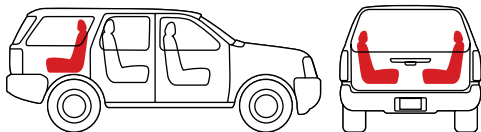

WARNING! DEATH OR SERIOUS INJURY CAN OCCUR.
CHECK YOUR Vehicle instruction book for information regarding your vehicle seat belt system(s). Not all vehicle seat belts work with this Child Restraint.

VEHICLE COMPATIBILITY – Unsafe Vehicle Seat Belt Systems + Seating

DO NOT use this Child Restraint with the following seat belt systems:

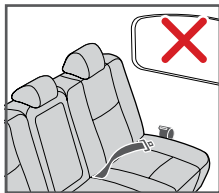

**Lap belts with
emergency locking retractor**

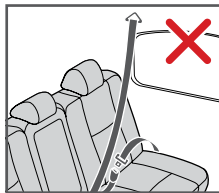

Motorized (automatic)

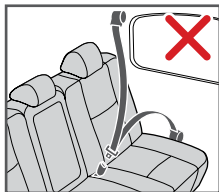

**Lap/Shoulder with
two retractors**

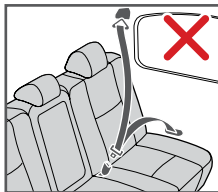

Door mounted

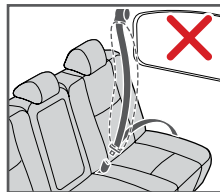

Inflatable



BASE INSTALLATION WITH LOWER ANCHORS

We recommend using the load leg to optimize safety of the child in the seat. Load leg should be placed in stowed position when not in use. If installing without the load leg, bypass step 1 and proceed to step 2.

LEVELING BASE

- 1 Press the load leg release button on bottom of the base and pull load leg out from storage. Place on the vehicle seat with the load leg extended toward the front of the vehicle cushion.

NOTE: We recommend removing the vehicle floor mat before installation.

- 2 Lift the level adjust handle on the top of the base to extend the foot and change the recline angle. Check the bubble level angle indicator on either side of the base. The base is level when the bubble is fully between the lines. NO partial bubble allowed.

NOTE: If the bubble is not visible, lower the foot to the lowest position and complete installation. Upon completion, the bubble should fall between the two lines.

NOTE: Vehicle must be parked on a level surface to properly level the base.

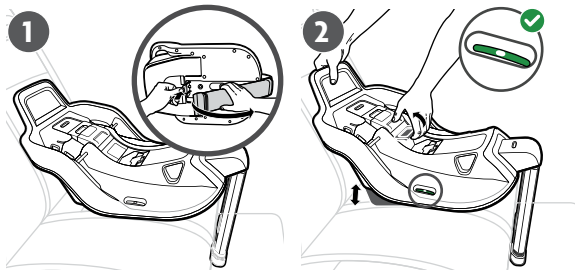

If proper angle cannot be achieved with level adjustable foot, a rolled towel may be used. Foot must be in fully extended position.

BASE INSTALLATION WITH LOWER ANCHOR

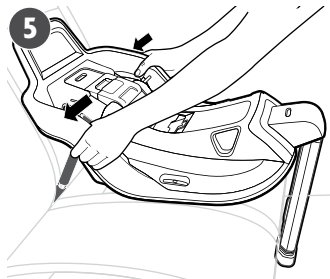
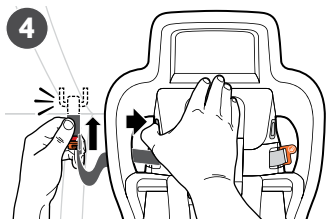
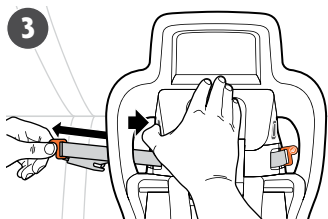

- 3 Locate the lower anchor connectors on either side of the base and remove by pushing the corresponding orange button while pulling the connector out of the lower anchor storage pocket.
- 4 Attach the lower anchor connectors to the vehicle lower anchors located in the vehicle seat bight (crease of seat).

NOTE: Check lower anchor connectors are in the upright position.

- 5 Apply pressure firmly into the base allowing excess lower anchor connector webbing to retract and tighten.

NOTE: A rocking motion may be necessary to retract excess lower anchor connector webbing.

NOTE: Anti-Rebound+ Panel must make full contact with the seat back. If it does not make full contact, please refer to the Waterfall note (pg 27).

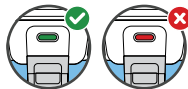

Installation is complete when tightness indicator turns from **RED** to **GREEN** and stays green when downward push is discontinued.



BASE INSTALLATION WITH LOWER ANCHORS

CONTINUE IF USING PREFERRED LOAD LEG INSTALLATION



INSTALLING LOAD LEG

1 After the base is secured, rotate load leg extension until its showing fully green.



2 Using two hands, separate the two ends to remove any RED showing.



NOTE: After installing the load leg, check the level angle indicator on base to ensure the bubble is still within the lines.

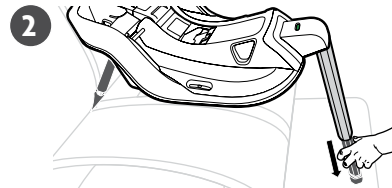
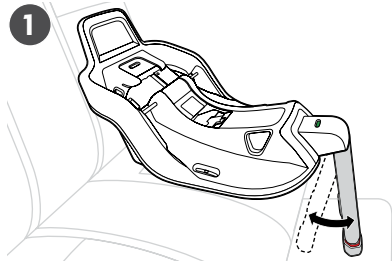

REVIEW SAFETY CHECK ON PAGE 28.

All steps must be achieved.

BASE INSTALLATION WITH LOWER ANCHORS

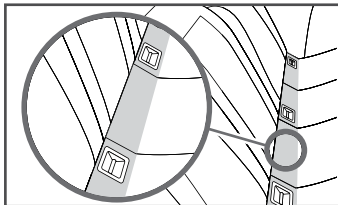

WHAT IS A WATERFALL?

Many late model vehicles have what industry professionals call a waterfall. A waterfall is the wedge of material where your vehicle seat cushion and seat back meet. In some cases, this may prevent the Anti-Rebound+ Panel from making full contact with the vehicle seat back.

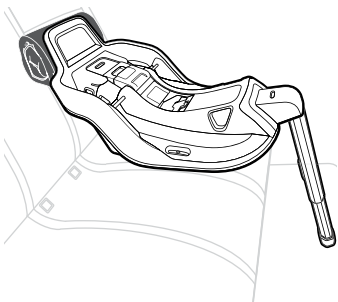

This is an easy issue to resolve by following the steps below:

- 1 Uninstall your MESA MAX base.
- 2 Adjust the level adjustment foot to achieve proper recline level.
- 3 Push the base into the seat back. If there is a gap between the top of the MESA MAX base and the back of the vehicle seat, place a rolled hand towel in the gap flush with the top of the base.
- 4 Proceed to **BASE INSTALLATION WITH LOWER ANCHORS** (pg 24). Follow Safety Check (pg 28) to confirm proper installation.



BASE INSTALLATION WITH LOWER ANCHORS – Safety Check

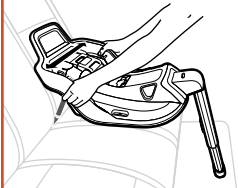

Base doesn't move more than 1" side-to-side and front-to-back at the belt path. Lower anchor connector webbing is secure and untwisted.



Ensure tightness indicator is **GREEN** after each use. If it is not, apply pressure by pushing base into seat bight (crease of seat) to tighten.



Recline angle is correct. Check the level angle indicator on base to ensure the bubble is still within the lines. **NO** partial bubble allowed.

BASE INSTALLATION WITH LOWER ANCHORS – Safety Check

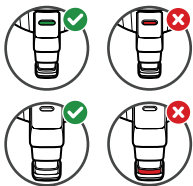

Make sure the load leg is secured and contacts the vehicle floor. Check that the load leg angle indicator is **GREEN**. Any **RED** showing indicates that the load leg is not properly level with the vehicle floor. Always store the load leg under base when not in use.

ALL STEPS MUST BE COMPLETE.
If not, return to pg 24 and start over.



BASE INSTALLATION WITH LOWER ANCHORS

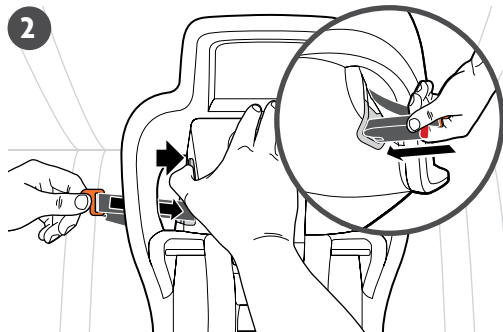
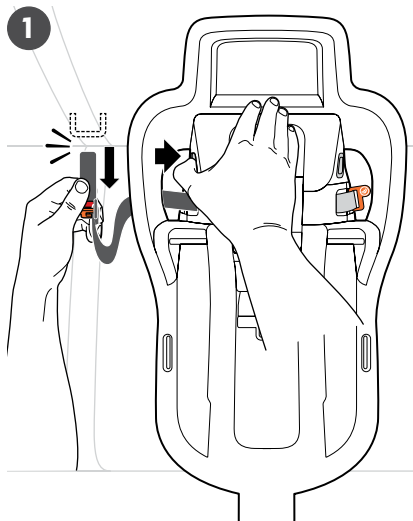

UNINSTALLING BASE

- 1 Press the red button on the lower anchor connector while pulling the connector off the vehicle anchor.
- 2 Store lower anchor connectors in designated housing found on each side of the base.

BASE INSTALLATION WITH LOWER ANCHORS

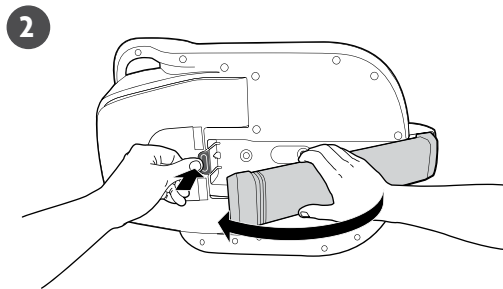
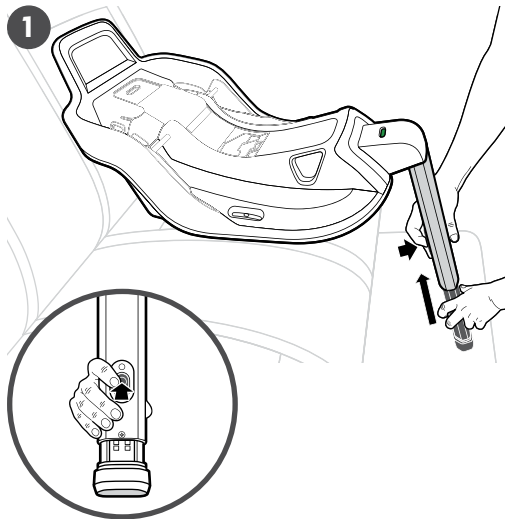

STORING LOAD LEG

- 1 Push load leg extension release button on back of load leg and bring foot up until it locks into place.
- 2 Bring load leg back into base until it clicks into secure/stowed position.



BASE INSTALLATION WITH VEHICLE SEAT BELT

We recommend using the load leg to optimize safety of the child in the seat. Load leg should be placed in stowed position when not in use. If installing without the load leg, bypass step 1 and proceed to step 2.

LEVELING BASE

- 1 Press the load leg release button on bottom of the base and pull load leg out from storage. Place on the vehicle seat with the load leg extended toward the front of the vehicle cushion.

NOTE: We recommend removing the vehicle floor mat before installation.

- 2 Lift the level adjust handle on the top of the base to extend the foot and change the recline angle. Check the bubble level angle indicator on either side of the base. The base is level when the bubble is fully between the lines. NO partial bubble allowed.

NOTE: If the bubble is not visible, lower the foot to the lowest position and complete installation. Upon completion, the bubble should fall between the two lines.

NOTE: Vehicle must be parked on a level surface to properly level the base.

- 3 Open the lock-off door by lifting the top then the bottom portions to access the belt path.

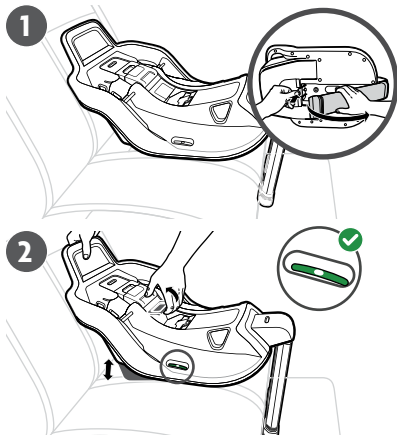

BASE INSTALLATION WITH VEHICLE SEAT BELT



3

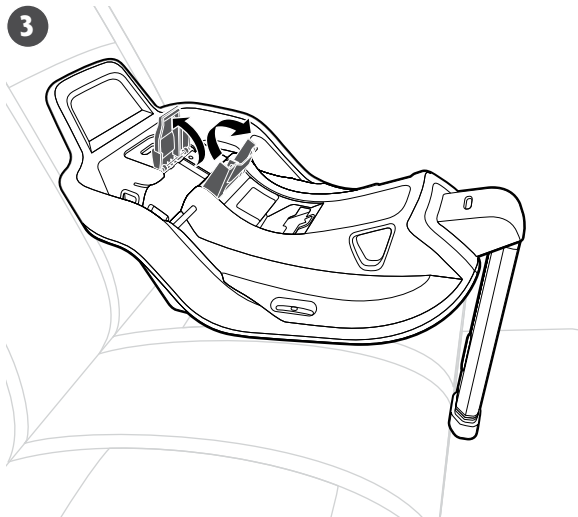

If proper angle cannot be achieved with level adjustable foot, a rolled towel may be used. Foot must be in fully extended position.

Proceed to chosen installation method:

LAP/SHOULDER ROUTING METHOD PAGE 34

LAP BELT ONLY ROUTING METHOD PAGE 36



BASE INSTALLATION WITH VEHICLE SEAT BELT

Lap/Shoulder Routing Method

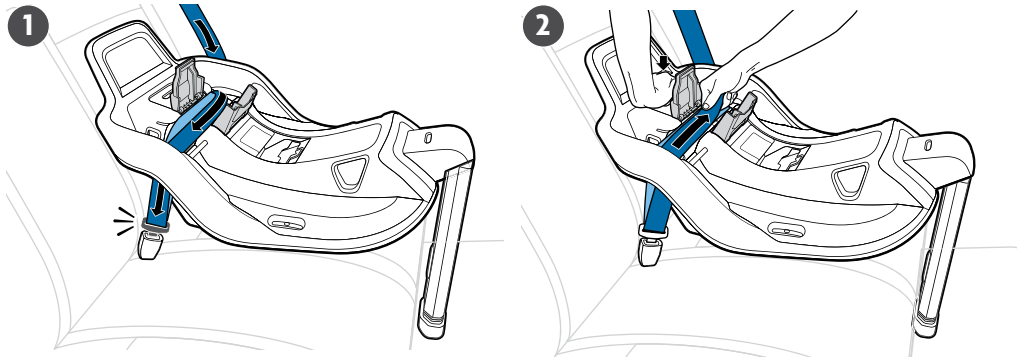

- 1 Route the vehicle belt through the vehicle belt path while guiding the lap portion of the belt as close as possible to the top of the lock-off where the door hinges. Buckle the vehicle belt.
- 2 Hold shoulder portion of belt above base. With one hand, push down in the direction of the seat bight (crease of seat) and hold firm as you pull shoulder belt.

BASE INSTALLATION WITH VEHICLE SEAT BELT

Lap/Shoulder Routing Method

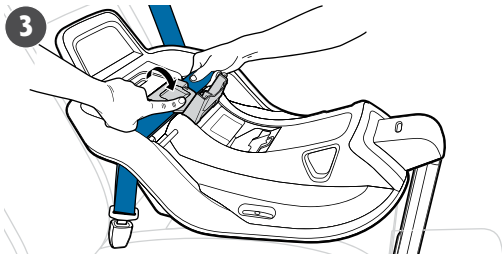

- 3 While holding the shoulder belt firmly, check the indicator. If green, close the top of the lock-off over the lap/shoulder belt.

NOTE: Tightness indicator should be green.

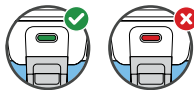

- 4 Push the bottom of the lock-off all the way down until you hear an audible click.

NOTE: Anti-Rebound+ Panel must make full contact with the seat back. If it does not make full contact, refer to the Waterfall note (pg 39).

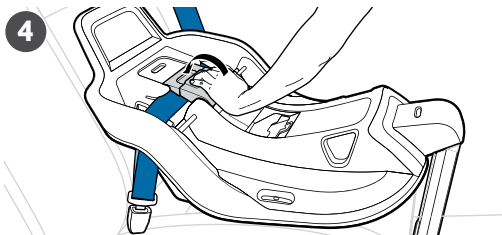

LOAD LEG INSTALLATION CONTINUE TO PAGE 38.

REVIEW SAFETY CHECK ON PAGE 40.

All steps must be achieved.



BASE INSTALLATION WITH VEHICLE SEAT BELT

Lap Belt Only Routing Method

- 1 Route the vehicle belt through the belt path while guiding the lap portion of the belt as close as possible to the topside of the lock-off where the door hinges. Buckle the vehicle
- 2 With one hand push down base and hold firm as you pull lap belt to tighten and remove any slack.

NOTE: Tightness indicator should be green.

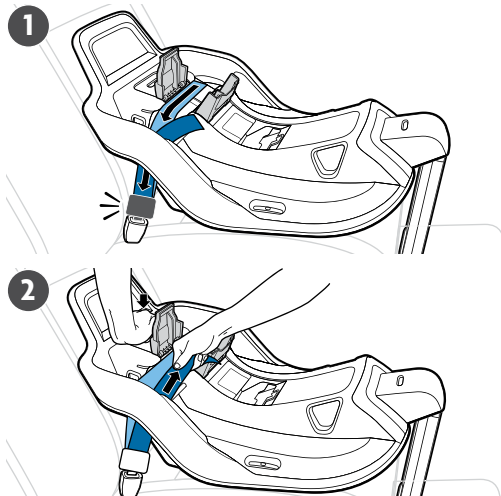
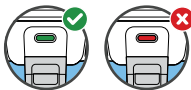

BASE INSTALLATION WITH VEHICLE SEAT BELT

Lap Belt Only Routing Method

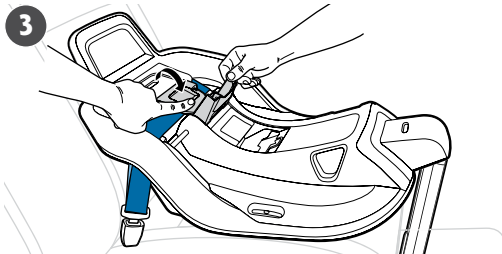

- 3 While holding the excess lap belt webbing, firmly check the indicator. If GREEN, close the top of the lock-off over the vehicle belt.

NOTE: Tightness indicator should be green.

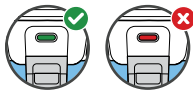

- 4 Push the bottom of the lock-off all the way down until you hear an audible click.

NOTE: Anti-Rebound+ Panel must make full contact with the seat back. If it does not make full contact, please refer to the Waterfall note (pg 39).

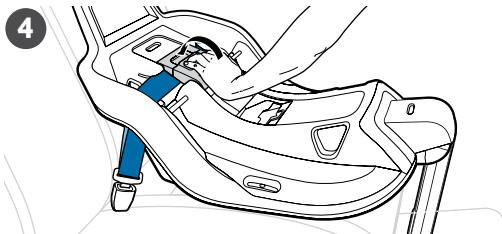

LOAD LEG INSTALLATION CONTINUE TO PAGE 38.

REVIEW SAFETY CHECK ON PAGE 40.

All steps must be achieved.



BASE INSTALLATION WITH VEHICLE SEAT BELT

CONTINUE IF USING PREFERRED LOAD LEG INSTALLATION



INSTALLING LOAD LEG

1 After the base is secured, rotate load leg extension until its showing fully green.



2 Using two hands, separate the two ends to remove any RED showing.



NOTE: After installing the load leg, check the level angle indicator on base to ensure the bubble is still within the lines.

REVIEW SAFETY CHECK ON PAGE 40.

All steps must be achieved.

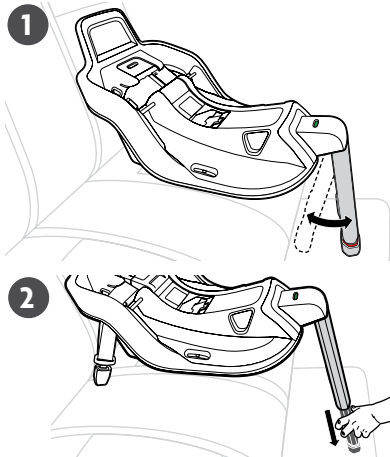

BASE INSTALLATION WITH VEHICLE SEAT BELT

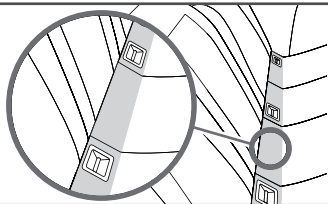

WHAT IS A WATERFALL?

Many late model vehicles have what industry professionals call a waterfall. A waterfall is the wedge of material where your vehicle seat cushion and seat back meet. In some cases, this may prevent the Anti-Rebound+ Panel from making full contact with the vehicle seat back.

This is an easy issue to resolve by following the steps below:

- 1 Uninstall your MESA MAX base.
- 2 Adjust the level adjustment foot to achieve proper recline level.
- 3 Push the base into the seat back. If there is a gap between the top of the MESA MAX base and the back of the vehicle seat, place a rolled hand towel in the gap flush with the top of the base.
- 4 Proceed to **BASE INSTALLATION WITH VEHICLE SEAT BELT** (pg 34 or 36) based on your method of installation). Follow Safety Check (pg 40) to confirm proper installation.

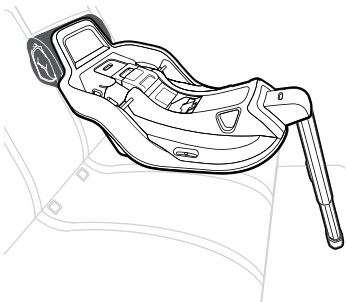



BASE INSTALLATION WITH VEHICLE SEAT BELT

Safety Check

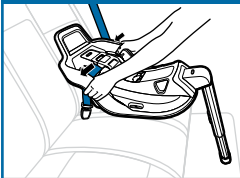

Lock-off must be used at all times when installing with a vehicle seat belt.
Vehicle Belt is secure and untwisted.
Base doesn't more than 1" side-to-side and front-to-back at the belt path.

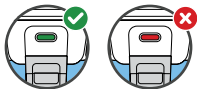

Ensure tightness indicator is **GREEN** after each use. If it is not, reinstall base.



Recline angle is correct. Check the level angle indicator on base to ensure the bubble is still within the lines. **NO** partial bubble allowed.

BASE INSTALLATION WITH VEHICLE SEAT BELT

Safety Check

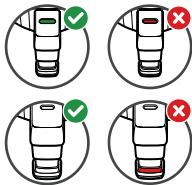

Make sure the load leg is secured and contacts the vehicle floor.
Check that the load leg angle indicator is **GREEN**. Any **RED** showing indicates that the load leg is not properly level with the vehicle floor.
Always store the load leg under base when not in use.

ALL STEPS MUST BE COMPLETE.

If not, return to pg 32 and start over.



BASE INSTALLATION WITH VEHICLE SEAT BELT

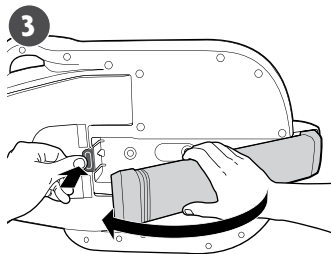
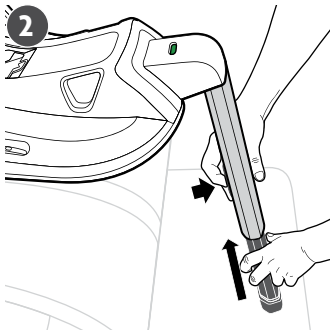
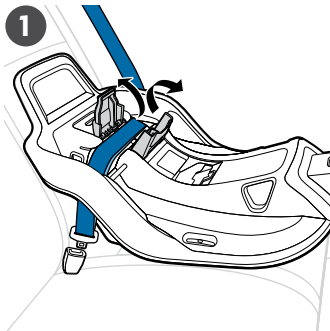

UNINSTALLING BASE AND STORING LOAD LEG

- 1 Unbuckle seat belt. Open lock-off and remove seat belt.
- 2 Push load leg extension release button on back of load leg and bring foot up until it locks into place.
- 3 Bring load leg back into base until it clicks into secure/stowed position.

CARRIER INSTALLATION WITH VEHICLE SEAT BELT



DETERMINING BEST INSTALLATION METHOD

Carrier-only Installation can only be performed using the vehicle seat belt.
There are (3) methods of carrier-only installation.

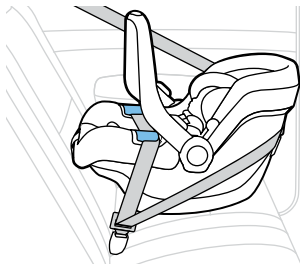

LAP/SHOULDER PREFERRED ROUTING METHOD

Installation with both the lap and shoulder belt.

PAGE 45

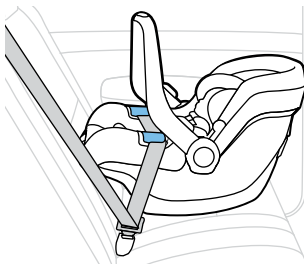

LAP/SHOULDER OPTIONAL ROUTING METHOD

Installation with both the lap and shoulder belt.

PAGE 48

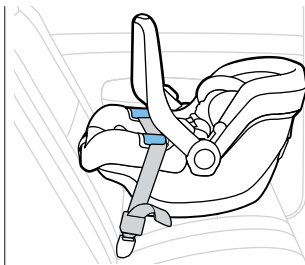

LAP BELT ONLY METHOD

No shoulder belt is used.
This method applies to vehicle with no shoulder belt and aircraft.

PAGE 50



CARRIER INSTALLATION WITH VEHICLE SEAT BELT

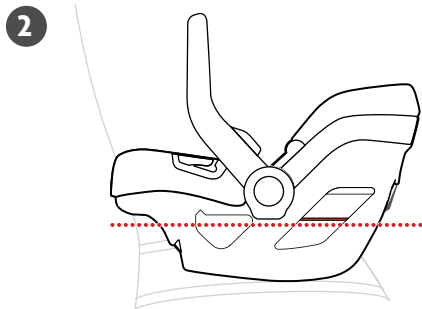
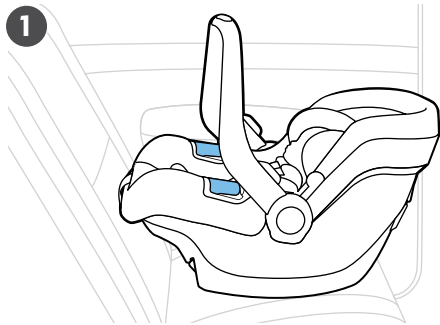

LEVELING THE CARRIER

- 1 Place the carrier rear-facing on the vehicle seat.
- 2 The red line on the carrier must be level to the vehicle floor.



For a more stable installation, a rolled towel may be used.

CARRIER INSTALLATION WITH VEHICLE SEAT BELT

Lap/Shoulder Belt Preferred Routing Method



If shoulder belt does not route around the back of the MESA MAX carrier, follow **LAP/SHOULDER BELT OPTIONAL ROUTING METHOD** page 48.

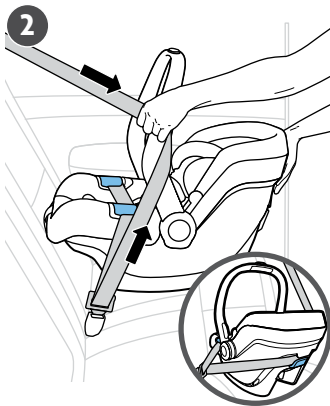
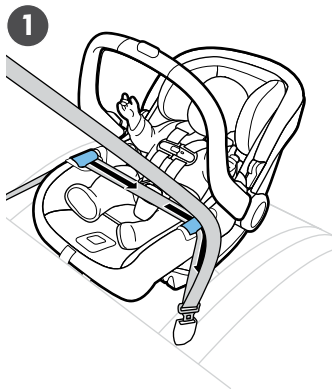

- 1 Route the lap portion of the seat belt through both lap belt guides on the carrier, and buckle the seat belt.
- 2 Route belt around the seat back through the rear belt guide.



CARRIER INSTALLATION WITH VEHICLE SEAT BELT

Lap/Shoulder Belt Preferred Routing Method

- 3 Lock vehicle seat belt.
- 4 Push the carrier into the vehicle seat bight (crease of the seat) and gently apply pressure from behind the carrier into the vehicle seat back. At the same time, pull on the shoulder portion of the vehicle belt closest to the buckle and hold tightly.

NOTE: Be mindful of canopy.

- 5 Feed excess webbing into the vehicle retractor.
- 6 Rotate carry handle forward to the (4th) rebound position when in use.

NOTE: Check that the carrier is still properly leveled.

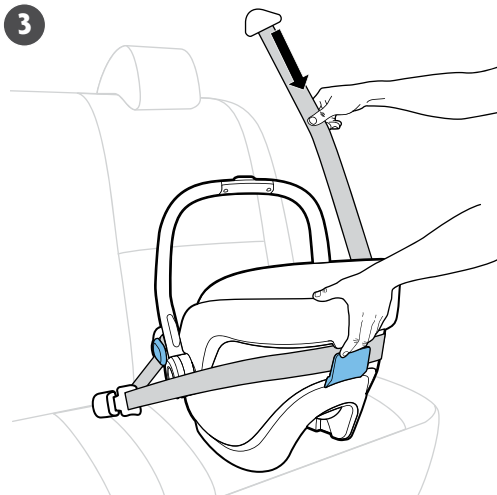

CARRIER INSTALLATION WITH VEHICLE SEAT BELT

Lap/Shoulder Belt Preferred Routing Method

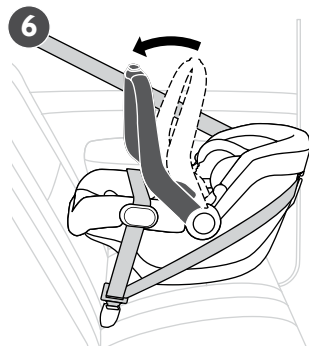
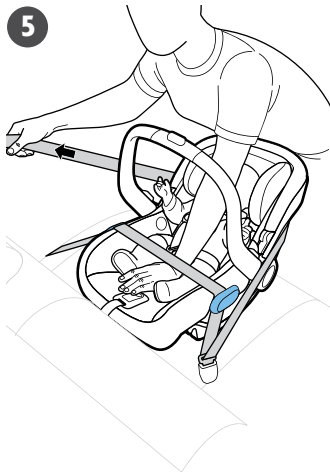
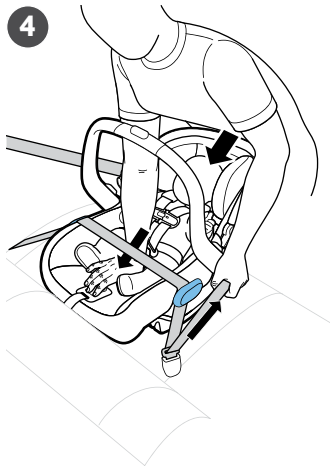

**REVIEW SAFETY CHECK
ON PAGE 51.**

All steps must be achieved.



CARRIER INSTALLATION WITH VEHICLE SEAT BELT

Lap/Shoulder Optional Routing Method

- 1 Route the lap portion of the seat belt through both lap belt guides on the carrier, and buckle the seat belt.
- 2 Lock vehicle seat belt.
- 3 Push the carrier into the vehicle seat bight (crease of the seat) and gently apply pressure from behind the carrier into the vehicle seat back. At the same time, pull on the shoulder portion of the vehicle belt closet to the buckle and hold tightly.

NOTE: Be mindful of canopy.

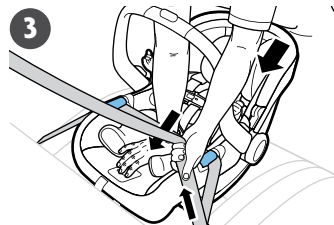
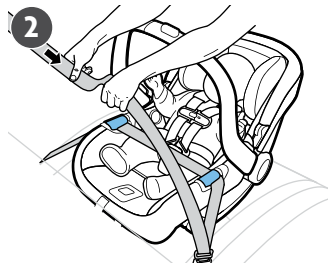
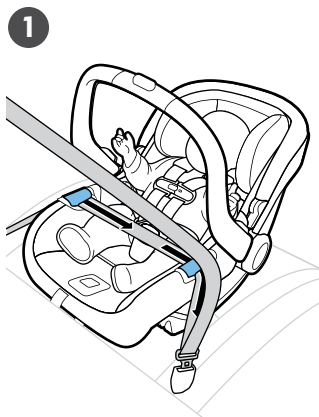

CARRIER INSTALLATION WITH VEHICLE SEAT BELT

Lap/Shoulder Optional Routing Method

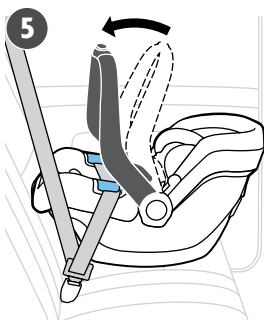
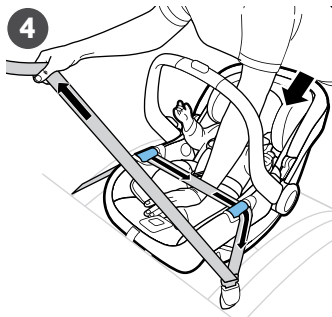

- 4 Feed excess webbing into the vehicle retractor.
 - 5 Rotate carry handle forward to the (4th) rebound position when in use.
- NOTE:** Check that the carrier is still properly leveled.

**REVIEW SAFETY CHECK
ON PAGE 51.**

All steps must be achieved.



CARRIER INSTALLATION WITH VEHICLE SEAT BELT

Lap Belt Only Routing Method

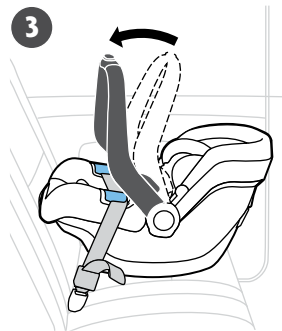
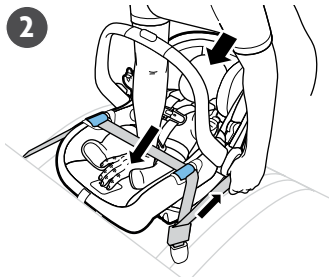

- 1 Route the lap belt through both guides on the carrier, and buckle the seat belt.
- 2 Push the carrier into the vehicle seat bight (crease of the seat) and gently apply pressure from behind the carrier into the vehicle seat back. At the same time, pull on the loose portion of the lap belt closet to the buckle.

NOTE: Be mindful of canopy

- 3 Rotate carry handle forward to the (4th) rebound position when in use.

NOTE: Check that the carrier is still properly leveled.

**REVIEW SAFETY CHECK
ON PAGE 51.**

All steps must be achieved.

CARRIER INSTALLATION WITH VEHICLE SEAT BELT

Safety Check

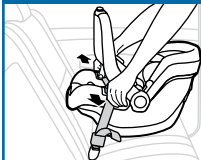

Carrier doesn't move more than 1" side-to-side and more than 1" front-to-back at the belt path.

Vehicle belt is secure and untwisted.

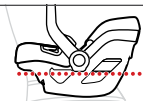

Angle is correct when The **RED** line on the carrier is level with the vehicle floor.

Seating position is permitted by both UPPAbaby and your vehicle manufacturer for use with the type of Vehicle Seat Belt.

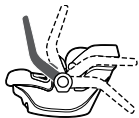

The carry handle must be locked in the (4th) rebound position when in use.



CARRIER INSTALLATION WITH VEHICLE SEAT BELT

Aircraft Installation



THIS CHILD SEAT IS CERTIFIED FOR AIRCRAFT USE.

UPPAbaby and The FAA recommend that a child weighing up to 40 lbs (18 kg) use a certified harnessed child seat while traveling on an aircraft. Contact the airline about their policy prior to traveling.

AIRCRAFT INSTALLATION

When installing this child restraint on an airplane, install the same way as **CARRIER INSTALLATION WITH VEHICLE SEAT BELT/LAP BELT ONLY ROUTING METHOD** (PAGE 50).

NOTE: Make sure that the aircraft buckle does not interfere with the belt guides on the infant carrier.

⚠️ WARNING! DO NOT use base with aircraft installation. Only the carrier is certified for aircraft use. Inflatable seat belts are not compatible with this child restraint.

SAFETY REMINDERS AND TIPS

- Notify the airline ahead of time that you'll be traveling with a child restraint.
- Install this carrier in a window seat to avoid blocking the aisle.
- Ask for a seat belt extender if the lap belt is too short.
- Use only on a forward-facing aircraft seat.
- **DO NOT** use this restraint if a secure installation cannot be achieved.
- Carry handle should be in the 4th (rebound) position.

GENERAL USE – Infant Insert

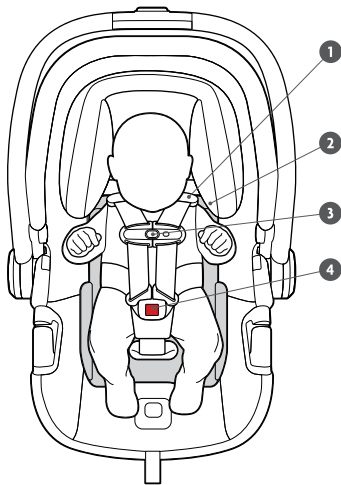

To ensure a better fit for smaller infants, use the Infant Insert (included) between 4 and 11 lbs.

This Infant Insert was designed to optimize fit and body positioning for your child. When you can achieve all fit criteria without the insert, it can be removed.

NOTE: Use insert until all criteria below is met.

- 1 Harness straps are at or slightly below shoulders

NOTE: Harness pads are optional. They must be removed when securing a preemie.

- 2 Bottom of the headrest is positioned at or 1" above shoulders

- 3 Chest clip is at armpit level

- 4 Crotch buckle rests securely against child with no gaps. When using insert, child should not sit on top of the buckle.

NEVER use non-regulated products with this child restraint, unless approved by UPPAbaby.

GENERAL USE – SIP Carriage + Harness Positioning

This child restraint has an adjustable head restraint and no-rethread harness system that is easy to adjust to properly secure the child.

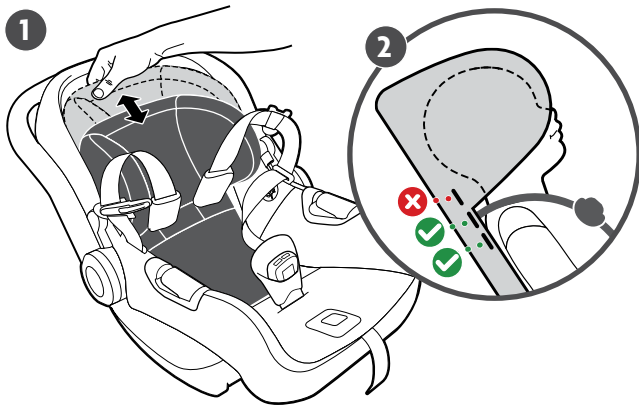

- 1 Adjust the head restraint by gripping the top of the carriage and sliding it up or down.
- 2 The Harness should be at the shoulders or slightly below.

GENERAL USE – Securing Your Child

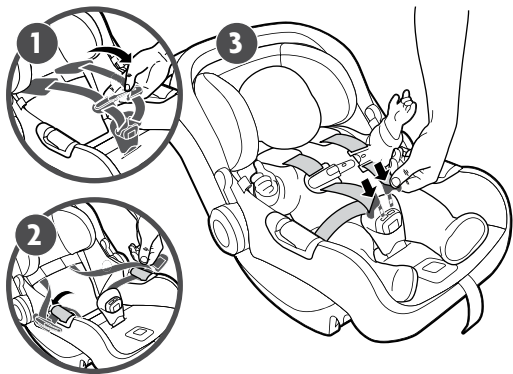

- 1 Loosen the harness by pressing on the harness adjuster release button and pulling out the shoulder straps toward the front of the carrier.
- 2 Open the retainer clip, unbuckle the harness, and tuck harness straps into belt guides to hold harness open.
- 3 Place infant in child restraint making sure their body is making full contact with the seating surface. Place harness over child and insert buckle tongues into the buckle until a “click” is heard. Pull up on the buckle tongues to make sure they are locked.

NEVER use non-regulated products with this child restraint, unless approved by UPPAbaby.

GENERAL USE – Securing Your Child

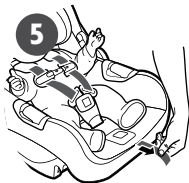
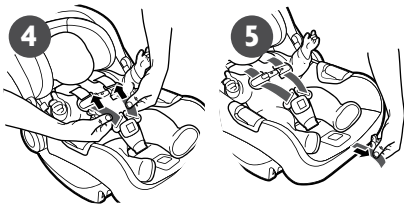

- 4 Pull up on the harness to remove excess slack around the child's legs.
- 5 Pull the harness adjuster strap to snugly adjust the harness straps around your child.
- 6 Close retainer clip and position at armpit level. Make sure the shoulder pads don't interfere with positioning the chest clip.

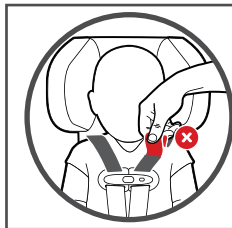
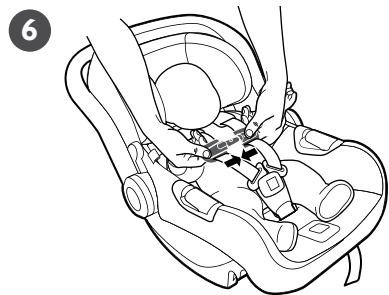

HARNESS SHOULD BE SNUG.

Pinch harness webbing at child's shoulders. If you can pinch webbing, the harness is too loose and should be tightened.

GENERAL USE – Attaching Carrier to Base



- 1 Place carrier on base until a click is heard.
- 2 Check for a secure connection by pulling up on carry handle.

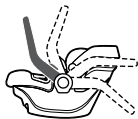

Carry handle must be locked in the (4th) rebound position when in use in the vehicle.

GENERAL USE – Removing Carrier from Base

- 1 Pull and hold carrier release button on back of the carrier.
- 2 Lift carrier off base.

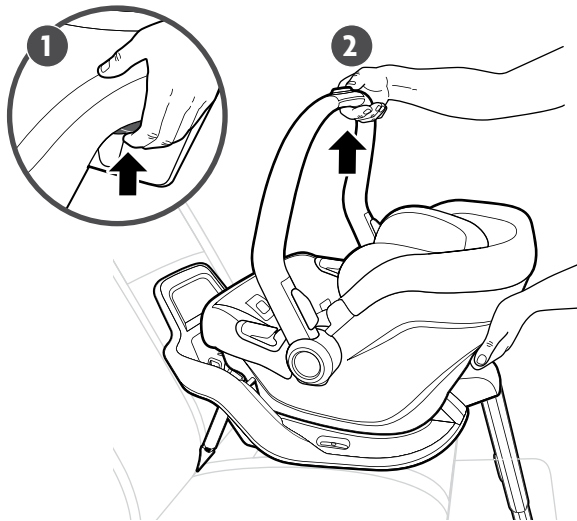

GENERAL USE – Using Canopy

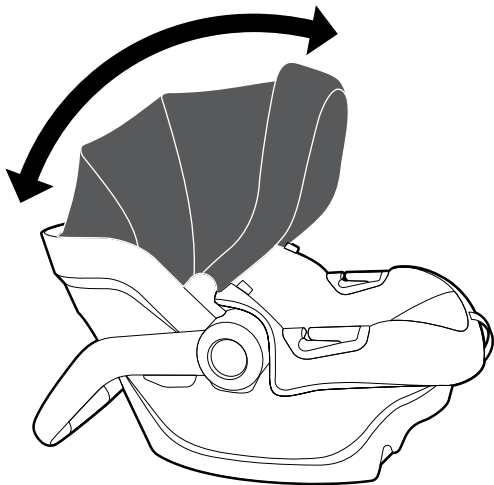

Hide-away canopy easily adjusts to one of three (3) positions.

TO EXTEND CANOPY

Slowly pull forward on main canopy frame until resting in desired position.

TO RETRACT/STOW CANOPY

Gently push downward on main canopy frame allowing the center support and canopy fabric to guide into the storage compartment in carrier.

NOTE: Canopy can be in full extension or storage position while in the vehicle.

GENERAL USE – Using Carry Handle

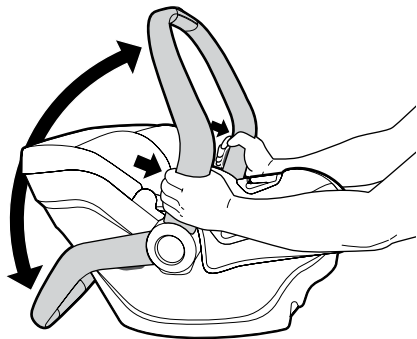

To adjust the carry handle position, squeeze both handle adjustment buttons and rotate forward or backward.

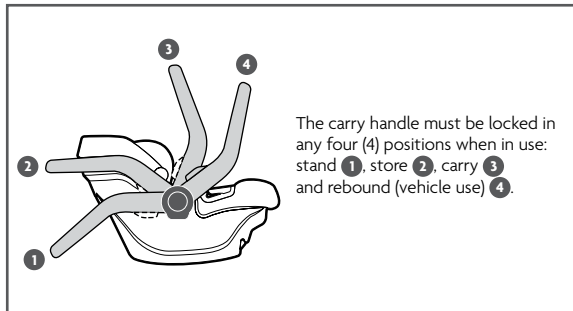

The carry handle must be locked in any four (4) positions when in use: stand ①, store ②, carry ③ and rebound (vehicle use) ④.

⚠️WARNING! NEVER hang toys and other objects from the carry handle when using in the vehicle. These products have not been tested by UPPAbaby and therefore are not approved for use with this child restraint.

GENERAL USE – Safety Check

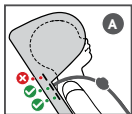

- This child restraint is for rear-facing use only.
- The seat must be tightly installed in a forward-facing vehicle seat.
- The Harness should be at the shoulders or slightly below. **A**.
- Retainer clip must be at armpit level and harness straps should be snug **B**.
- The top of child's head should not be less than 1" from the top of the headrest when in its highest position.
- The child must weigh between 4 and 35 pounds and be no taller than 32".
- The back seat is the safest place for children aged 13 and under.
- **NEVER** use non-regulated products with this child restraint, unless approved by UPPAbaby.
- **NEVER** place in front of an active airbag.
- Install using lower anchor or the vehicle seat belt, not both.
- **DO NOT** secure an infant in the carrier with extra material, bulky clothing, or extra padding. Instead place a blanket over the harness after properly securing the child **C**.
- The carry handle must be locked in the (4th) rebound position when in use.
- While in vehicle, the canopy can be fully extended or in storage compartment.
- Adjust base to the appropriate angle by using the angle indicator on the sides of the base or the level to ground line on the carrier.
- Always check the tightness indicator is green after each use.
- Always secure an unoccupied child restraint; in a crash an unsecured infant car seat may injure occupants in your vehicle.

STROLLER COMPATIBILITY – Fitting Carrier to Stroller Frame

Prior to fitting MESA MAX carrier to stroller frame, engage brake on stroller and remove toddler seat from frame.

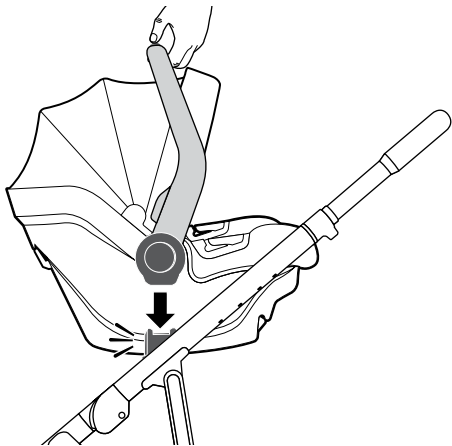

- 1 With carrier facing stroller handle, align carrier handle hubs with attachment posts on stroller.
- 2 Let carrier slide onto attachment posts. An audible click indicates proper attachment.
- 3 Lift up on car seat handle to check attachment.

COMPATIBLE WITH:

VISTA V2, VISTA 2015+, CRUZ V2, CRUZ

STROLLER COMPATIBILITY – Releasing Carrier from Stroller Frame

- 1 Engage and hold the stroller release button on the top of the carry handle.
- 2 Lift the carrier off stroller frame.

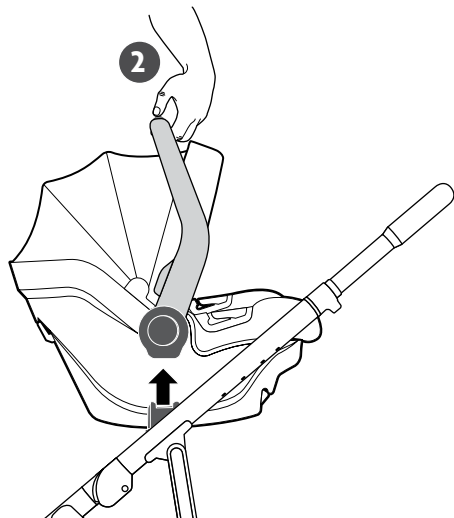
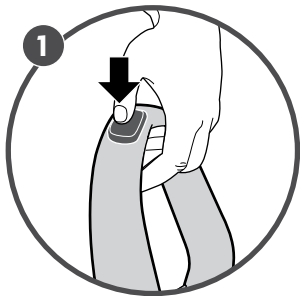

CARE + MAINTENANCE – SIP Padding Removal

Following are fabric removal instructions for cleaning.

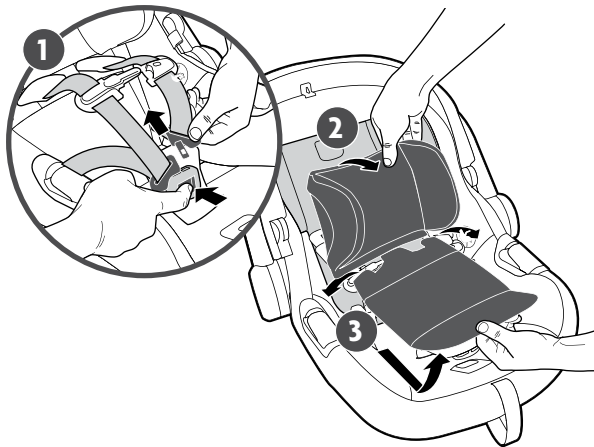

- 1 Unbuckle retainer clip and harness. Remove harness pads.
- 2 Pull forward on SIP padding releasing harness straps.
- 3 Pull SIP padding down from bottom and release.

CARE + MAINTENANCE – Seat Padding Removal

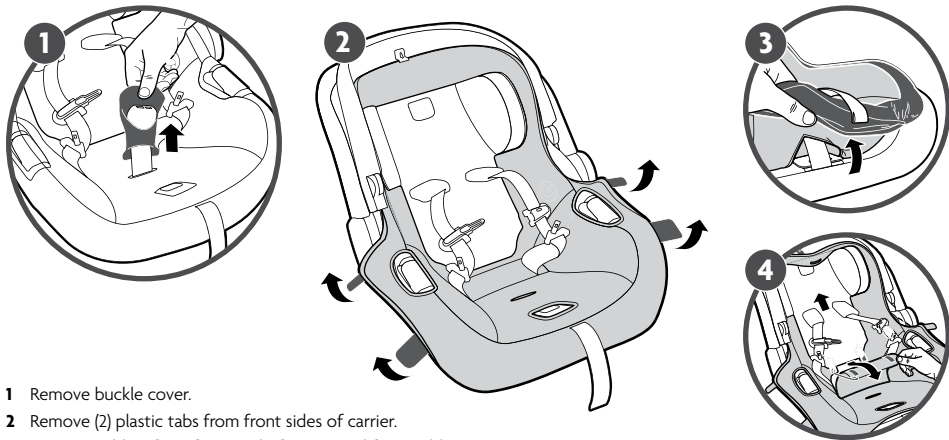

- 1 Remove buckle cover.
- 2 Remove (2) plastic tabs from front sides of carrier.
- 3 Loosen padding from front end of carrier and free padding from around harness adjuster release button housing.
- 4 Raise SIP to highest position and pull back padding panel.

CARE + MAINTENANCE – Seat Padding Removal

- 5 Slide SIP to lowest position to remove top portion of seat fabric.
- 6 Pull seat padding up and forward to fully remove.

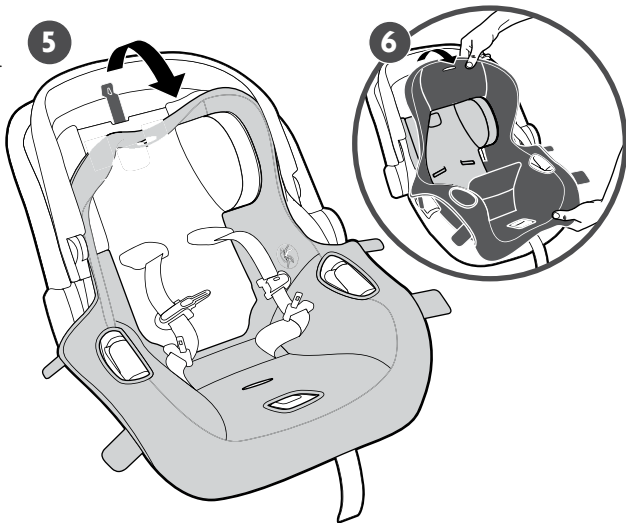

CARE + MAINTENANCE – Seat Padding Installation

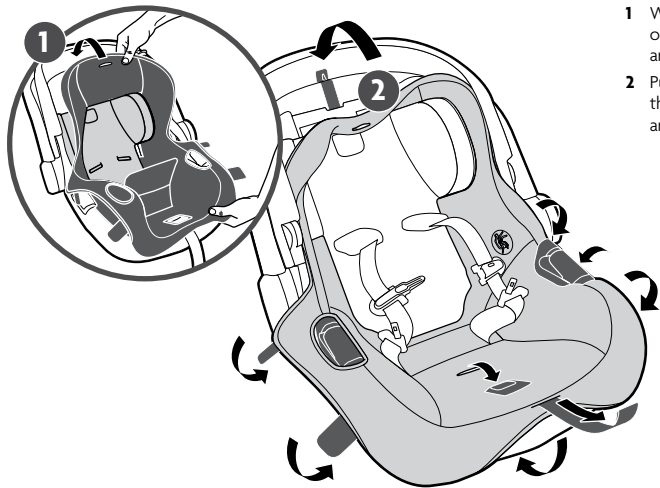

- 1 With the SIP in the lowest position, lay seat pad over carrier, open Velcro flap and fit opening around SIP/headrest.
- 2 Put top plastic tab through designated hole and then secure fabric by tucking it around the edges around top of the seat.

CARE + MAINTENANCE – Seat Padding Installation

- 3 While the Velcro flap is still open, adjust SIP headrest to highest position, bring the harness straps to the front, then secure the Velcro underneath.
- 4 Continue to tuck fabric around the outside edges of the seat including around the belt guides.
- 5 Before securing the front edge of the fabric, thread the harness adjustment webbing through the designated slot.
- 6 Thread the crotch buckle through the slot then add the crotch buckle padding.
- 7 Tuck the wings under the seat padding to secure. Finish by securing the fabric around the front edge of the seat and tucking.

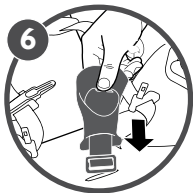
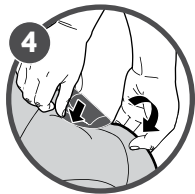
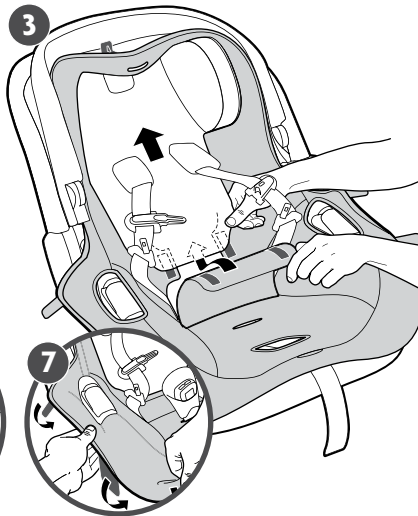

CARE + MAINTENANCE – SIP Padding Installation



- 1 Insert lower part of SIP carriage into pocket on the back of SIP padding.
- 2 Guide harness straps back into slots in SIP padding.
- 3 Secure SIP cover tightly around SIP ears.

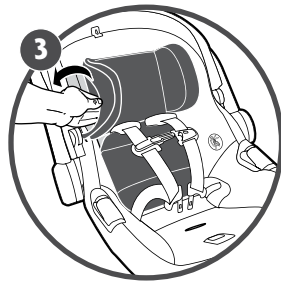
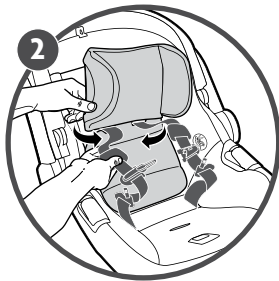

CARE + MAINTENANCE – Cleaning

CLEANING FABRICS

Fabrics include: seat pad, infant inserts, buckle pads and shoulder pad.



Machine wash in cold water on gentle cycle with mild detergent. **DO NOT** bleach.



Dry flat and away from direct sunlight before re-use or storage.



DO NOT iron or dry clean.

CLEANING HARNESS WEBBING + CANOPY



Spot clean using warm water with mild detergent. **DO NOT** bleach.



Air dry completely before re-use or storage.

CLEANING PLASTIC



Spot clean using warm water with mild detergent.



Towel dry completely before re-use or storage.

CLEANING BUCKLE AND LOWER ANCHOR CONNECTOR HARDWARE - Buckle should fasten with a “click” if not, rinse under warm running water. **DO NOT** use detergents or lubricants.

WARRANTY



Welcome to the UPPAbaby family! We are with you for the long haul. Register your car seat within three months to claim your Limited Lifetime Warranty*.

Register your product at: uppababy.com/register

*Lifetime warranty applies to UPPAbaby car seats and only the original owner, within the lifetime of the product. To receive your Limited Lifetime Warranty, you MUST register your car seat within three months of purchase and provide a valid purchase receipt from an authorized UPPAbaby retailer. The “lifetime” of the product is defined as the period of use by the registrant for use with his/her children up to 7 years from date of manufacture.

Your UPPAbaby product is warranted to be free from any manufacturing defects for a period of 2 years from the date of purchase under normal use and in compliance with the operating instructions.

This warranty is not transferable and extends only to the original retail purchaser and is only valid when supplied with proof of purchase from an authorized retailer. Proof of purchase must be retained for this warranty.

The warranty is valid only in the original country of purchase. This warranty is subject to the conditions set forth by country in which the items were purchased. Conditions may vary. UPPAbaby will not ship replacement or repair parts out of the country of purchase.

UPPAbaby will provide replacement parts or conduct repairs as determined fitting by the company. UPPAbaby reserves the right to exchange item with a replacement part. Some parts may be replaced with newer model parts as the product is improved over time.

WARRANTY

This warranty does not cover:

- Defects caused by misuse or poor maintenance. (Please refer to the product instruction manual for guidance on item use and maintenance).
- Damage caused by improper installation of UPPAbaby parts and/or accessories. (Please refer to product instruction booklet for guidance on item assembly and use).
- Damage caused by corrosion mold or rust due to poor maintenance, service or storage.
- Damage resulting from normal wear and tear.
- Damage or degradation caused by the sun, sweat, detergents, damp storage conditions or frequent washings.
- Repairs or modifications carried out by a third party.
- Product purchased from an unauthorized retailer. (Approved retailers are listed on our website uppababy.com).
- Second owners and users other than the registrant.
- Damage resulting from airline shipping and handling.
- Products Involved in an accident.

UPPAbaby reserves the right to determine if warranty terms and conditions have been met.

For warranty service: In the US and CA please contact UPPAbaby customer service (844) 823-3132 and visit uppababy.com/support to send an email.



USA | UPPAbaby, 276 Weymouth Street, Rockland, MA 02370

uppababy.com | 1.844.823.3132

Model 1001-MSM-US

All rights reserved. © 2022 UPPAbaby. UPPAbaby and all associated logos are trademarks. All product specifications are correct at time of print. UPPAbaby reserves the right to change anything at any time without prior notice. Color representation is as close as print processes allow. Not all colors available at all retailers. UbMAN106-V12